

The background of the entire page is a photograph of two people in a laboratory or workshop setting. A woman with dark hair tied up, wearing a blue lab coat and glasses on her head, is holding a small, orange-colored circuit board. She is looking down at it with a focused expression. Next to her, a man wearing a black baseball cap, glasses, and a green lab coat is also looking at the board. In the foreground, there is a table with various electronic components, including a laptop, a breadboard with wires, and some clear plastic containers. The lighting is bright and even, typical of an indoor workspace.

# INTEL<sup>®</sup> FPGA PRODUCT CATALOG

Version 16.1

# CONTENTS

## Overview

- Intel® FPGA Solutions Portfolio 1

## Devices

- Generation 10 Device Portfolio
  - Generation 10 FPGAs and SoCs 2
  - Stratix® 10 FPGA and SoC Overview 3
  - Stratix 10 FPGA Features 5
  - Stratix 10 SoC Features 7
  - Stratix 10 TX Features 9
  - Arria® 10 FPGA and SoC Overview 12
  - Arria 10 FPGA Features 13
  - Arria 10 SoC Features 15
  - MAX® 10 FPGA Overview 17
  - MAX 10 FPGA Features 18
- 28 nm Device Portfolio
  - Stratix V FPGA Features 19
  - Arria V FPGA and SoC Features 21
  - Cyclone® V FPGA Features 23
  - Cyclone V SoC Features 25
- 40 nm Device Portfolio
  - Stratix IV FPGA Features 27
  - Arria II GZ and GX FPGA Features 29
- 60 nm Device Portfolio
  - Cyclone IV GX and E FPGA Features 31
  - Cyclone III and Cylone III LS FPGA Features 33
- MAX CPLD Series
  - MAX V and MAX II CPLD Features 35
- Configuration Devices 37
- Device Ordering Codes 38
- Enpirion® Power Solutions Portfolio 44

## Design Tools

- Intel Quartus® Prime Software 47
- DSP Builder for Intel FPGAs 50
- Intel FPGA SDK for OpenCL™ 51
- Intel SoC FPGA Embedded Design Suite 52
- Nios® II Processor Embedded Design Suite 53

## Operating System Support and Processors

- SoC Operating System Support 54
- Nios II Processor Operating System Support 55
- Nios II Processor 56
- Customizable Processor Portfolio 57

## Intellectual Property

- Intel FPGA and Partner IP Functions 58

## Protocols

- Transceiver Protocols 62

## Development Kits

- Intel FPGA and Partner Development Kits 64
- SoC System on Modules 72
- Single-Board Computer 74

## Solutions

- Intel FPGA Design Solutions Network 74

## Training





- Training Overview 76
- Instructor-Led, Virtual, and Online Classes 77
- Online Training 78

# INTEL FPGA SOLUTIONS PORTFOLIO

Intel delivers the broadest portfolio of programmable logic devices—FPGAs, SoCs, and CPLDs—together with software tools, intellectual property (IP), embedded processors, customer support, and technical training. Intel's product leadership, excellent value, and superior quality of service give you a measurable advantage. Bring your great ideas to life faster, better, and more cost effectively.

## FPGAs and CPLDs

Intel FPGAs and CPLDs (formerly Altera® FPGAs and CPLDs) give you the flexibility to innovate, differentiate, and stay ahead in the market. We have four classes of FPGAs to meet your market needs, from the industry's highest density and performance to the most cost effective.

HIGH-END FPGAs	MIDRANGE FPGAs	LOWEST COST AND POWER FPGAs	NON-VOLATILE FPGAs AND LOW-COST CPLDs
 <p><b>Stratix®</b> FPGA • SoC</p>	 <p><b>Arria®</b> FPGA • SoC</p>	 <p><b>Cyclone®</b> FPGA • SoC</p>	 <p><b>MAX®</b> FPGA • CPLD</p>
<ul style="list-style-type: none"> <li>• Highest bandwidth, highest density</li> <li>• Integrated transceiver variants</li> <li>• Design entire systems on a chip</li> </ul>	<ul style="list-style-type: none"> <li>• Balanced cost, power, and performance</li> <li>• Integrated transceiver and processor variants</li> <li>• Comprehensive design protection</li> </ul>	<ul style="list-style-type: none"> <li>• Lowest system cost and power</li> <li>• Integrated transceiver and processor variants</li> <li>• Fastest time to market</li> </ul>	<ul style="list-style-type: none"> <li>• Instant-on, non-volatile solution</li> <li>• Single-chip, dual-configuration non-volatile FPGA</li> <li>• Low-cost, low-power CPLDs</li> </ul>

## SoCs

SoCs bring high integration and advanced system, power, and security management capabilities to your platform. Intel SoCs (formerly Altera SoCs) are supported by industry-standard ARM\* tools and a broad ecosystem of operating systems and development tools.

HIGH-END SoCs	MIDRANGE SoCs	LOWEST COST AND POWER SoCs
<ul style="list-style-type: none"> <li>• 64 bit quad-core ARM Cortex*-A53 processor</li> <li>• Performance/power efficiency</li> <li>• Virtualization support</li> </ul>	<ul style="list-style-type: none"> <li>• 32 bit dual-core ARM Cortex-A9 processor</li> <li>• 1.5 GHz maximum CPU frequency</li> <li>• Hardened floating-point digital signal processing (DSP)</li> <li>• ARM Development Studio 5 (DS-5*) Intel Edition tools</li> </ul>	<ul style="list-style-type: none"> <li>• 32 bit dual-core ARM Cortex-A9 processor</li> <li>• 925 MHz maximum CPU frequency</li> <li>• Broad ecosystem support</li> <li>• ARM DS-5 Intel Edition tools</li> </ul>

## Power Solutions

Power your systems with Enpirion power solutions. Our integrated power management products provide an industry-leading combination of small footprint, low-noise performance, and high efficiency. Enpirion power system-on-chip (PowerSoC) products provide a qualified and reliable solution that enables you to complete your design faster.



## Productivity-Enhancing Design Software, Embedded Processing, IP, Development Kits, and Training

With Intel, you get a complete design environment and a wide choice of design tools—all built to work together so your designs are up and running fast. You can try one of our training classes to get a jump-start on your designs. Choose Intel and see how we enhance your productivity and make a difference to your bottom line.



# GENERATION 10 FPGAS AND SoCs

Intel's Generation 10 FPGAs and SoCs optimize process technology and architecture to deliver the industry's highest performance and highest levels of system integration at the lowest power. Generation 10 families include Stratix 10, Arria 10, and MAX 10 FPGAs.

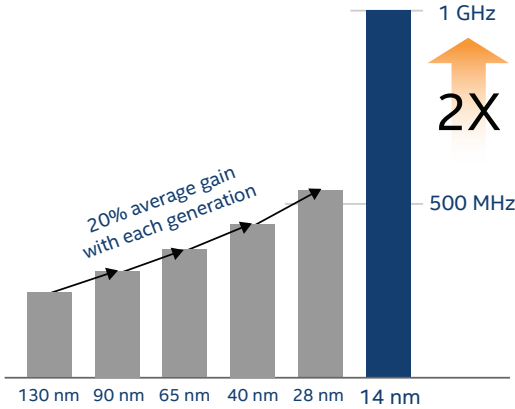

## Stratix® 10

### Description

- 2X core performance with revolutionary HyperFlex™ architecture
- Up to 70% power savings
- Highest density FPGA with up to 5.5 M logic elements (LEs)
- 64 bit quad-core ARM Cortex-A53 processor system
- Up to 10 tera floating point operations per second (TFLOPS) single-precision floating-point throughput
- Built on Intel's 14 nm Tri-Gate process technology

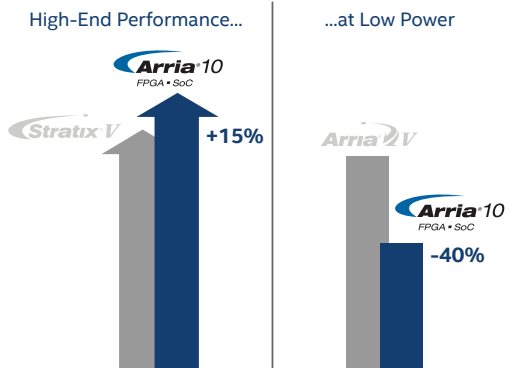

## Arria® 10

FPGA • SoC

### Description

- 15% higher performance than current high-end devices
- 40% lower midrange power
- 1.5 GHz dual-core ARM Cortex-A9 processor
- Best-in-class IP core support, including 100G Ethernet, 150G/300G Interlaken, and PCI Express\* (PCIe\*) Gen3
- Built on TSMC's 20 nm process technology

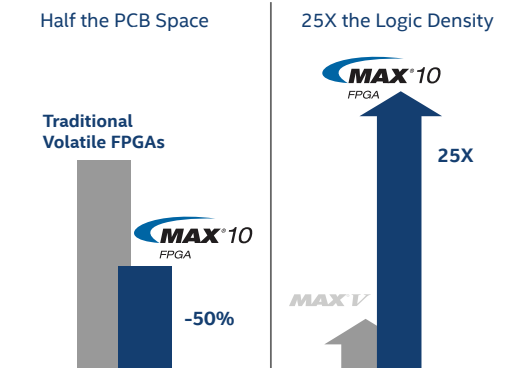

## MAX® 10

FPGA

### Description

- Single-chip, dual-configuration non-volatile FPGA
- Optimal system component integration for half the PCB space of traditional volatile FPGAs
- Broad range of IP including analog-to-digital converters (ADCs), DSP, and the Nios II embedded soft processor

# STRATIX 10 FPGA AND SoC OVERVIEW

Stratix 10 FPGAs and SoCs deliver breakthrough advantages in performance, power efficiency, density, and system integration, unmatched in the industry. Featuring the revolutionary HyperFlex core fabric architecture and built on the Intel 14 nm Tri-Gate process, Stratix 10 devices deliver 2X core performance gains over previous-generation, high-performance FPGAs with up to 70% lower power.

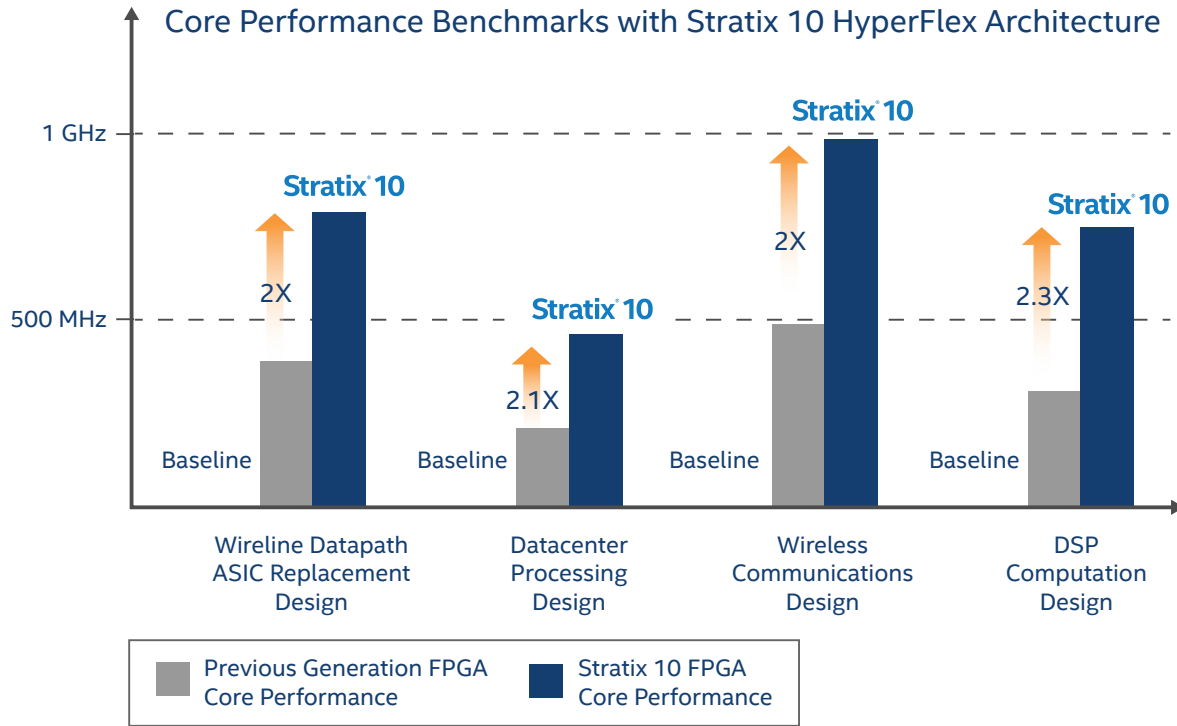

The figure above shows the core performance benchmarks achieved by early access customers using the Stratix 10 HyperFlex architecture. With the 2X performance increase, customers in multiple end markets can achieve a significant improvement in throughput and reduce area utilization, with up to 70% lower power.

Stratix 10 FPGA and SoC system integration breakthroughs include:

- Heterogeneous 3D System-in-Package (SiP) integration
- The highest density FPGA fabric with up to 5.5 million LEs
- Up to 10 TFLOPS of IEEE 754 compliant single-precision floating-point DSP throughput
- Secure Device Manager (SDM) with the most comprehensive security capabilities
- Integrated quad-core 64 bit ARM Cortex-A53 hard processor system up to 1.5 GHz
- Complementary optimized and validated Enpirion power solutions

These unprecedented capabilities make Stratix 10 devices uniquely positioned to address the design challenges in next-generation, high-performance systems in virtually all end markets including wireline and wireless communications, computing, storage, military, broadcast, medical, and test and measurement.

Communications



- 400G/500G/1T optical transmission
- 200G/400G bridging and aggregation
- 982 MHz remote radio head
- Mobile backhaul
- 5G wireless communications

Computing and Storage



- Data center server acceleration
- High-performance computing (HPC)
- Oil and gas exploration
- Bioscience

Defense



- Next-generation radar
- Secure communications
- Avionics and guidance systems

Broadcast

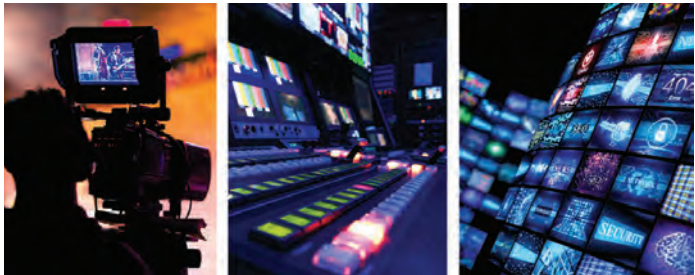

- High-end broadcast studio
- High-end broadcast distribution
- Headend encoder or EdgeQAM or converged multiservice access platform (CMAP)

# STRATIX 10 FPGA FEATURES

View device ordering codes on [page 38](#)

PRODUCT LINE		GX 400	GX 650	GX 850	GX 1100	GX 1650	GX 2100	GX 2500	GX 2800	GX 4500	GX 5500	
Resources	LEs <sup>1</sup>	378,000	612,000	841,000	1,092,000	1,624,000	2,005,000	2,422,000	2,753,000	4,463,000	5,510,000	
	Adaptive logic modules (ALMs)	128,160	207,360	284,960	370,080	550,540	679,680	821,150	933,120	1,512,820	1,867,680	
	ALM registers	512,640	829,440	1,139,840	1,480,320	2,202,160	2,718,720	3,284,600	3,732,480	6,051,280	7,470,720	
	Hyper-Registers from HyperFlex architecture	Millions of Hyper-Registers distributed throughout the monolithic FPGA fabric										
	Programmable clock trees synthesizable	Hundreds of synthesizable clock trees										
	eSRAM memory blocks	-	-	1	1	2	2	-	-	-	-	-
	eSRAM memory size (Mb)	-	-	45	45	90	90	-	-	-	-	-
	M20K memory blocks	1,537	2,489	3,477	4,401	5,851	6,501	9,963	11,721	7,033	7,033	
	M20K memory size (Mb)	30	49	68	86	114	127	195	229	137	137	
	MLAB memory size (Mb)	2	3	4	6	8	11	13	15	23	29	
	Variable-precision DSP blocks	648	1,152	2,016	2,520	3,145	3,744	5,011	5,760	1,980	1,980	
	18 x 19 multipliers	1,296	2,304	4,032	5,040	6,290	7,488	10,022	11,520	3,960	3,960	
	Peak fixed-point performance (TMACS) <sup>2</sup>	2.6	4.6	8.1	10.1	12.6	15.0	20.0	23.0	7.9	7.9	
Peak floating-point performance (TFLOPS) <sup>3</sup>	1.0	1.8	3.2	4.0	5.0	6.0	8.0	9.2	3.2	3.2		
I/O and Architectural Features	Secure device manager	AES-256/SHA-256 bitstream encryption/authentication, physically unclonable function (PUF), ECDSA 256/384 boot code authentication, side channel attack protection										
	Maximum user I/O pins	392	400	736	736	704	704	1160	1160	1640	1640	
	Maximum LVDS pairs 1.6 Gbps (RX or TX)	192	192	360	360	336	336	576	576	816	816	
	Total full duplex transceiver count	24	48	48	48	96	96	96	96	24	24	
	GXT full duplex transceiver count (up to 30 Gbps)	16	32	32	32	64	64	64	64	16	16	
	GX full duplex transceiver count (up to 17.4 Gbps)	8	16	16	16	32	32	32	32	8	8	
	PCIe hard intellectual property (IP) blocks (Gen3 x16)	1	2	2	2	4	4	4	4	1	1	
Memory devices supported	DDR4, DDR3, LPDDR3, RDRAM 3, QDR IV, QDR II+, QDR II+ Extreme, QDR II, HMC, MoSys											

Package Options and I/O Pins: General-Purpose I/O (GPIO) Count, High-Voltage I/O Count, LVDS Pairs, and Transceiver Count<sup>4</sup>

F1152 pin (35 mm x 35 mm, 1.0 mm pitch)	392,8,192,24	392,8,192,24	-	-	-	-	-	-	-	-	-
F1760 pin (42.5 mm x 42.5 mm, 1.0 mm pitch)	-	400,16,192,48	-	-	-	-	-	-	-	-	-
F1760 pin (42.5 mm x 42.5 mm, 1.0 mm pitch)	-	-	688,16,336,48	688,16,336,48	688,16,336,48	688,16,336,48	688,16,336,48	688,16,336,48	688,16,336,48	-	-
F2112 pin (47.5 mm x 47.5 mm, 1.0 mm pitch)	-	-	736,16,360,48	736,16,360,48	-	-	-	-	-	-	-
F2397 pin (50 mm x 50 mm, 1.0 mm pitch)	-	-	-	-	704,32,336,96	704,32,336,96	704,32,336,96	704,32,336,96	704,32,336,96	-	-
F2912 pin (55 mm x 55 mm, 1.0 mm pitch)	-	-	-	-	-	-	1160,8,576,24	1160,8,576,24	1640,8,816,24	1640,8,816,24	1640,8,816,24

Notes:

- LE counts valid in comparing across Intel FPGA devices, and are conservative vs. competing FPGAs.
- Fixed-point performance assumes the use of pre-adder.
- Floating-point performance is IEEE 754 compliant single precision.
- A subset of pins for each package are used for high-voltage, 3.0 V and 2.5 V interfaces.
- All data is preliminary, and may be subject to change without prior notice.

344,8,168,24 Numbers indicate total GPIO count, high-voltage I/O count, LVDS pairs, and transceiver count.

Indicates pin migration path.

# STRATIX 10 SoC FEATURES

View device ordering codes on [page 38](#).

PRODUCT LINE	SX 400	SX 650	SX 850	SX 1100	SX 1650	SX 2100	SX 2500	SX 2800	SX 4500	SX 5500
LEs <sup>1</sup>	378,000	612,000	841,000	1,092,000	1,624,000	2,005,000	2,422,000	2,753,000	4,463,000	5,510,000
Adaptive logic modules (ALMs)	128,160	207,360	284,960	370,080	550,540	679,680	821,150	933,120	1,512,820	1,867,680
ALM registers	512,640	829,440	1,139,840	1,480,320	2,202,160	2,718,720	3,284,600	3,732,480	6,051,280	7,470,720
Hyper-Registers from HyperFlex architecture	Millions of Hyper-Registers distributed throughout the monolithic FPGA fabric									
Programmable clock trees synthesizable	Hundreds of synthesizable clock trees									
eSRAM memory blocks	-	-	1	1	2	2	-	-	-	-
eSRAM memory size (Mb)	-	-	45	45	90	90	-	-	-	-
M20K memory blocks	1,537	2,489	3,477	4,401	5,851	6,501	9,963	11,721	7,033	7,033
M20K memory size (Mb)	30	49	68	86	114	127	195	229	137	137
MLAB memory size (Mb)	2	3	4	6	8	11	13	15	23	29
Variable-precision DSP blocks	648	1,152	2,016	2,520	3,145	3,744	5,011	5,760	1,980	1,980
18 x 19 multipliers	1,296	2,304	4,032	5,040	6,290	7,488	10,022	11,520	3,960	3,960
Peak fixed-point performance (TMACS) <sup>2</sup>	2.6	4.6	8.1	10.1	12.6	15.0	20.0	23.0	7.9	7.9
Peak floating-point performance (TFLOPS) <sup>3</sup>	1.0	1.8	3.2	4.0	5.0	6.0	8.0	9.2	3.2	3.2
Secure device manager	AES-256/SHA-256 bitsream encryption/authentication, physically unclonable function (PUF), ECDSA 256/384 boot code authentication, side channel attack protection									
Hard processor system <sup>4</sup>	Quad-core 64 bit ARM Cortex-A53 up to 1.5 GHz with 32 KB I/D cache, NEON* coprocessor, 1 MB L2 cache, direct memory access (DMA), system memory management unit, cache coherency unit, hard memory controllers, USB 2.0 x2, 1G EMAC x3, UART x2, SPI x4, I <sup>2</sup> C x5, general-purpose timers x7, watchdog timer x4									
Maximum user I/O pins	392	400	736	736	704	704	1160	1160	1640	1640
Maximum LVDS pairs 1.6 Gbps (RX or TX)	192	192	360	360	336	336	576	576	816	816
Total full duplex transceiver count	24	48	48	48	96	96	96	96	24	24
GXT full duplex transceiver count (up to 30 Gbps)	16	32	32	32	64	64	64	64	16	16
GX full duplex transceiver count (up to 17.4 Gbps)	8	16	16	16	32	32	32	32	8	8
PCIe hard intellectual property (IP) blocks (Gen3 x16)	1	2	2	2	4	4	4	4	1	1
Memory devices supported	DDR4, DDR3, LPDDR3, RDRAM 3, QDR IV, QDR II+, QDR II+ Extreme, QDR II, HMC, MoSys									
Package Options and I/O Pins: General-Purpose I/O (GPIO) Count, High-Voltage I/O Count, LVDS Pairs, and Transceiver Count <sup>5</sup>										
F1152 pin (35 mm x 35 mm, 1.0 mm pitch)	392,8,192,24	392,8,192,24	-	-	-	-	-	-	-	-
F1760 pin (42.5 mm x 42.5 mm, 1.0 mm pitch)	-	400,16,192,48	-	-	-	-	-	-	-	-
F1760 pin (42.5 mm x 42.5 mm, 1.0 mm pitch)	-	-	688,16,336,48	688,16,336,48	688,16,336,48	688,16,336,48	688,16,336,48	688,16,336,48	-	-
F2112 pin (47.5 mm x 47.5 mm, 1.0 mm pitch)	-	-	736,16,360,48	736,16,360,48	-	-	-	-	-	-
F2397 pin (50 mm x 50 mm, 1.0 mm pitch)	-	-	-	-	704,32,336,96	704,32,336,96	704,32,336,96	704,32,336,96	-	-
F2912 pin (55 mm x 55 mm, 1.0 mm pitch)	-	-	-	-	-	-	1160,8,576,24	1160,8,576,24	1640,8,816,24	1640,8,816,24

Notes:

- LE counts valid in comparing across Intel FPGA devices, and are conservative vs. competing FPGAs.
- Fixed-point performance assumes the use of pre-adder.
- Floating-point performance is IEEE 754 compliant single precision.
- Quad-core ARM Cortex-A53 hard processor system only available in Stratix 10 SX SoCs.
- A subset of pins for each package are used for high-voltage, 3.0 V and 2.5 V interfaces.
- All data is preliminary, and may be subject to change without prior notice.

344,8,168,24 Numbers indicate total GPIO count, high-voltage I/O count, LVDS pairs, and transceiver count.

Indicates pin migration path.

HARD PROCESSOR SYSTEM (HPS)	
Processor	Quad-core 64 bit ARM Cortex-A53 MPCore* processor
Maximum processor frequency	1.5 GHz <sup>1</sup>
Processor cache and co-processors	<ul style="list-style-type: none"> <li>L1 instruction cache (32 KB)</li> <li>L1 data cache (32 KB) with error correction code (ECC)</li> <li>Level 2 cache (1 MB) with ECC</li> <li>Floating-point unit (FPU) single and double precision</li> <li>ARM NEON* media engine</li> <li>ARM CoreSight* debug and trace technology</li> <li>System Memory Management Unit (SMMU)</li> <li>Cache Coherency Unit (CCU)</li> </ul>
Scratch pad RAM	256 KB
HPS DDR memory	DDR4, DDR3, and LP DDR3 (Up to 64 bit with ECC)
DMA controller	8 channels
EMAC	3X 10/100/1000 Ethernet media access controller (EMAC) with integrated DMA
USB on-the-go (OTG) controller	2X USB OTG with integrated DMA
UART controller	2X UART 16550 compatible
Serial peripheral interface (SPI) controller	4X SPI
I <sup>2</sup> C controller	5X I <sup>2</sup> C
Quad SPI flash controller	1X SIO, DIO, QIO SPI flash supported
SD/SDIO/MMC controller	1X eMMC 4.5 with DMA and CE-ATA support
NAND flash controller	1X ONFI 1.0 or later 8 and 16 bit support
General-purpose timers	4X
Software-programmable general-purpose I/Os (GPIOs)	Maximum 48 GPIOs
HPS DDR Shared I/O	3X 48 - May be assigned to HPS for HPS DDR access
Direct I/Os	48 I/Os to connect HPS peripherals directly to I/O
Watchdog timers	4X
Security	Secure device manager, Advanced Encryption Standard (AES) AES-256/SHA-256 bitsream encryption/authentication, PUF, ECDSA 256/384 boot code authentication, side channel attack protection

Notes:

- With overdrive feature.



# STRATIX 10 TX FEATURES

View device ordering codes on [page 38](#)

PRODUCT LINE	TX 1650	TX 2100	TX 2500	TX 2800
Logic elements (LEs) <sup>1</sup>	1,624,000	2,005,000	2,422,000	2,753,000
Adaptive logic modules (ALMs)	550,540	679,680	821,150	933,120
ALM registers	2,202,160	2,718,720	3,284,600	3,732,480
Hyper-Registers from HyperFlex architecture	Millions of Hyper-Registers distributed throughout the monolithic FPGA fabric			
Programmable clock trees synthesizable	Hundreds of synthesizable clock trees			
eSRAM memory blocks	2	2	–	–
eSRAM memory size (Mb)	90	90	–	–
M20K memory blocks	5,851	6,501	9,963	11,721
M20K memory size (Mb)	114	127	195	229
MLAB memory size (Mb)	8	11	13	15
Variable-precision digital signal processing (DSP) blocks	3,145	3,744	5,011	5,760
18 x 19 multipliers	6,290	7,488	10,022	11,520
Peak fixed-point performance (TMACS) <sup>2</sup>	12.6	15.0	20.0	23.0
Peak floating-point performance (TFLOPS) <sup>3</sup>	5.0	6.0	8.0	9.2
Secure device manager	AES-256/SHA-256 bitsream encryption/authentication, physically unclonable function (PUF), ECDSA 256/384 boot code authentication, side channel attack protection			
Hard processor system <sup>4</sup>	Quad-core 64 bit ARM* Cortex-A53 up to 1.5 GHz with 32KB I/D cache, NEON* coprocessor, 1 MB L2 cache, direct memory access (DMA), system memory management unit, cache coherency unit, hard memory controllers, USB 2.0 x2, 1G EMAC x3, UART x2, SPI x4, I <sup>2</sup> C x5, general purpose timers x7, watchdog timer x4			
Maximum user I/O pins	544	544	544	544
Maximum LVDS pairs 1.6 Gbps (RX or TX)	264	264	264	264
Total full duplex transceiver count	96	96	144	144
GXE transceiver count - PAM-4 (up to 56 Gbps) or NRZ (up to 30 Gbps)	36 PAM-4 72 NRZ	36 PAM-4 72 NRZ	60 PAM-4 120 NRZ	60 PAM-4 120 NRZ
GXT transceiver count - NRZ (up to 28.3 Gbps)	16	16	16	16
GX transceiver count - NRZ (up to 17.4 Gbps)	8	8	8	8
PCI Express (PCIe*) hard intellectual property (IP) blocks (Gen3 x16)	2	2	2	2
100G Ethernet MAC + RS FEC hard IP blocks	12	12	20	20
Memory devices supported	DDR4, DDR3, DDR2, DDR, QDR II, QDR II+, RLDRAM II, RLDRAM 3, HMC, MoSys			
Package Options and I/O Pins: General-Purpose I/O (GPIO) Count, High-Voltage I/O Count, LVDS Pairs, and Transceiver Count <sup>5</sup>				
F2112 pin (47.5 mm x 47.5 mm, 1.0 mm pitch)	544,16,264,72	544,16,264,72	544,16,264,72	544,16,264,72
F2397 pin (50 mm x 50 mm, 1.0 mm pitch)	440,8,216,96	440,8,216,96	440,8,216,96	440,8,216,96
F2912 pin (55 mm x 55 mm, 1.0 mm pitch)	–	–	296,8,144,144	296,8,144,144

Notes:  
 1. LE counts valid in comparing across Intel FPGA devices, and are conservative vs. competing FPGAs.  
 2. Fixed-point performance assumes the use of pre-adder.  
 3. Floating-point performance is IEEE 754 compliant single precision.  
 4. Quad-core ARM Cortex-A53 hard processor system present in all Stratix 10 TX devices.  
 5. A subset of pins for each package are used for high-voltage, 3.0 V and 2.5 V interfaces.  
 6. All data is preliminary, and may be subject to change without prior notice.

544, 16, 264, 72 Numbers indicate total GPIO count, high-voltage I/O count, LVDS pairs, and transceiver count.

Indicates pin migration path.

HARD PROCESSOR SYSTEM (HPS)	
Processor	Quad-core 64 bit ARM Cortex-A53 MPCore processor
Maximum processor frequency	1.5 GHz <sup>1</sup>
Processor cache and co-processors	<ul style="list-style-type: none"> <li>L1 instruction cache (32 KB)</li> <li>L1 data cache (32 KB) with error correction code (ECC)</li> <li>Level 2 cache (1 MB) with ECC</li> <li>Floating-point unit (FPU) single and double precision</li> <li>ARM NEON media engine</li> <li>ARM CoreSight debug and trace technology</li> <li>System Memory Management Unit (SMMU)</li> <li>Cache Coherency Unit (CCU)</li> </ul>
Scratch pad RAM	256 KB
HPS DDR memory	DDR4, DDR3, and LP DDR3 (Up to 64 bit with ECC)
DMA controller	8 channels
EMAC	3X 10/100/1000 Ethernet media access controller (EMAC) with integrated DMA
USB on-the-go (OTG) controller	2X USB OTG with integrated DMA
UART controller	2X UART 16550 compatible
Serial peripheral interface (SPI) controller	4X SPI
I <sup>2</sup> C controller	5X I <sup>2</sup> C
Quad SPI flash controller	1X SIO, DIO, QIO SPI flash supported
SD/SDIO/MMC controller	1X eMMC 4.5 with DMA and CE-ATA support
NAND flash controller	1X ONFI 1.0 or later 8 and 16 bit support
General-purpose timers	4X
Software-programmable general-purpose I/Os (GPIOs)	Maximum 48 GPIOs
HPS DDR Shared I/O	3X 48 - May be assigned to HPS for HPS DDR access
Direct I/Os	48 I/Os to connect HPS peripherals directly to I/O
Watchdog timers	4X
Security	Secure device manager, Advanced Encryption Standard (AES) AES-256/SHA-256 bitsream encryption/authentication, PUF, ECDSA 256/384 boot code authentication, side channel attack protection

Notes:  
 1. With overdrive feature.

# Stratix<sup>®</sup> 10

Stratix 10 FPGAs and SoCs deliver breakthrough advantages in performance, power efficiency, density, and system integration: advantages that are unmatched in the industry. Featuring the revolutionary HyperFlex core fabric architecture and built on the Intel 14 nm Tri-Gate process, Stratix 10 devices deliver 2X core performance gains over previous-generation, high-performance FPGAs with up to 70% lower power.



# ARRIA 10 FPGA AND SoC OVERVIEW

Arria 10 FPGAs and SoCs deliver the highest performance at 20 nm offering a one speed-grade performance advantage over competing devices. Arria 10 FPGAs and SoCs are up to 40% lower power than previous generation FPGAs and SoCs, and feature the industry's only hard floating-point DSP blocks with speeds up to 1,500 giga floating-point operations per second (GFLOPS). The Arria 10 FPGAs and SoCs are ideal for the following end market applications.

## Wireless



### Applications

- Remote radio head
- Mobile backhaul
- Active antenna
- Base station
- 4G/Long Term Evolution (LTE) macro eNB
- Wideband Code Division Multiple Access (W-CDMA)

## Cloud Service and Storage



### Applications

- Flash cache
- Cloud
- Server
- Financial
- Bioscience
- Oil and gas

## Broadcast



### Applications

- Switcher
- Server
- Encoder/decoder
- Capture cards
- Editing
- Monitors
- Multiviewers

# ARRIA 10 FPGA FEATURES

View device ordering codes on [page 38](#)

PRODUCT LINE		GX 160	GX 220	GX 270	GX 320	GX 480	GX 570	GX 660	GX 900	GX 1150	GT 900	GT 1150
Resources	Part number reference	10AX016	10AX022	10AX027	10AX032	10AX048	10AX057	10AX066	10AX090	10AX115	10AT090	10AT115
	LEs (K)	160	220	270	320	480	570	660	900	1,150	900	1,150
	System logic elements (K)	210	288	354	419	629	747	865	1,180	1,506	1,180	1,506
	Adaptive logic modules (ALMs)	61,510	83,730	101,620	118,730	181,790	217,080	250,540	339,620	427,200	339,620	427,200
	Registers	246,040	334,920	406,480	474,920	727,160	868,320	1,002,160	1,358,480	1,708,800	1,358,480	1,708,800
	M20K memory blocks	440	588	750	891	1,438	1,800	2,133	2,423	2,713	2,423	2,713
	M20K memory (Mb)	9	11	15	17	28	35	42	47	53	47	53
	MLAB memory (Mb)	1.0	1.8	2.4	2.8	4.3	5.0	5.7	9.2	12.7	9.2	12.7
	Hardened single-precision floating-point multipliers/ adders	156/156	191/191	830/830	985/985	1,368/1,368	1,523/1,523	1,688/1,688	1,518/1,518	1,518/1,518	1,518/1,518	1,518/1,518
	18 x 19 multipliers	312	382	1,660	1,970	2,736	3,046	3,376	3,036	3,036	3,036	3,036
	Peak fixed-point performance (GMACS) <sup>1</sup>	343	420	1,826	2,167	3,010	3,351	3,714	3,340	3,340	3,340	3,340
	Peak floating-point performance (GFLOPS)	140	172	747	887	1,231	1,371	1,519	1,366	1,366	1,366	1,366
Clocks, Maximum I/O Pins, and Architectural Features	Global clock networks	32	32	32	32	32	32	32	32	32	32	32
	Regional clocks	8	8	8	8	8	8	16	16	16	16	16
	I/O voltage levels supported (V)	1.2, 1.25, 1.35, 1.8, 2.5, 3.0										
		3 V I/O pins only: 3 V LVTTTL, 2.5 V CMOS										
		DDR and LVDS I/O pins: POD12, POD10, Differential POD12, Differential POD10, LVDS, RSDS, mini-LVDS, LVPECL										
	I/O standards supported	All I/Os: 1.8 V CMOS, 1.5 V CMOS, 1.2 V CMOS, SSTL-135, SSTL-125, SSTL-18 (I and II), SSTL-15 (I and II), SSTL-12, HSTL-18 (I and II), HSTL-15 (I and II), HSTL-12 (I and II), HSUL-12, Differential SSTL-135, Differential SSTL-125, Differential SSTL-18 (I and II), Differential SSTL-15 (I and II), Differential SSTL-12, Differential HSTL-18 (I and II), Differential HSTL-15 (I and II), Differential HSTL-12 (I and II), Differential HSUL-12										
	Maximum LVDS channels (1.6 G)	120	120	168	168	222	324	270	384	384	312	312
	Maximum user I/O pins	288	288	384	384	492	696	696	768	768	624	624
	Transceiver count (17.4 Gbps)	12	12	24	24	36	48	48	96	96	72	72
	Transceiver count (25.78 Gbps)	-	-	-	-	-	-	-	-	-	6	6
	PCIe hardened IP blocks (Gen3 x8)	1	1	2	2	2	2	2	4	4	4	4
	Maximum 3 V I/O pins	48	48	48	48	48	48	48	-	-	-	-
Memory devices supported	DDR4, DDR3, DDR2, QDR IV, QDR II+, QDR II+ Xtreme, LPDDR3, LPDDR2, RDRAM 3, RDRAM II, LDRAM II, HMC											

Package Options<sup>2</sup> and I/O Pins<sup>3</sup>: General-Purpose I/O (GPIO) Count, High-Voltage I/O Count, LVDS Pairs<sup>4</sup>, and Transceiver Count

U19	U484 pin (19 mm)	192, 48, 72, 6	192, 48, 72, 6	-	-	-	-	-	-	-	-	-
F27	F672 pin (27 mm)	240, 48, 96, 12	240, 48, 96, 12	240, 48, 96, 12	240, 48, 96, 12	-	-	-	-	-	-	-
F29	F780 pin (29 mm)	288, 48, 120, 12	288, 48, 120, 12	360, 48, 156, 12	360, 48, 156, 12	360, 48, 156, 12	-	-	-	-	-	-
F34	F1152 pin (35 mm)	-	-	384, 48, 168, 24	384, 48, 168, 24	492, 48, 222, 24	492, 48, 222, 24	492, 48, 222, 24	504, 0, 252, 24	504, 0, 252, 24	-	-
F35	F1152 pin (35 mm)	-	-	384, 48, 168, 24	384, 48, 168, 24	396, 48, 174, 36	396, 48, 174, 36	396, 48, 174, 36	-	-	-	-
KF40	F1517 pin (40 mm)	-	-	-	-	-	696, 96, 324, 36	696, 96, 324, 36	-	-	-	-
NF40	F1517 pin (40 mm)	-	-	-	-	-	588, 48, 270, 48	588, 48, 270, 48	600, 0, 300, 48	600, 0, 300, 48	-	-
RF40	F1517 pin (40 mm)	-	-	-	-	-	-	-	342, 0, 154, 66	342, 0, 154, 66	-	-
NF45	F1932 pin (45 mm)	-	-	-	-	-	-	-	768, 0, 384, 48	768, 0, 384, 48	-	-
SF45	F1932 pin (45 mm)	-	-	-	-	-	-	-	624, 0, 312, 72	624, 0, 312, 72	624, 0, 312, 72	624, 0, 312, 72
UF45	F1932 pin (45 mm)	-	-	-	-	-	-	-	480, 0, 240, 96	480, 0, 240, 96	-	-

- Notes:
- Fixed-point performance assumes the use of pre-adder.
  - All packages are ball grid arrays with 1.0 mm pitch, except for U19 (U484), which is 0.8 mm pitch.
  - A subset of pins for each package are used for 3.3 V and 2.5 V interfaces.
  - Each LVDS pair can be configured as either a differential input or a differential output.
  - Certain packages might not bond out all PCIe hard IP blocks.
  - All data is correct at the time of printing, and may be subject to change without prior notice. For the latest information, please visit [www.altera.com](http://www.altera.com).
- 192, 48, 72, 6 Numbers indicate GPIO count, high-voltage I/O count, LVDS pairs, and transceiver count.
- Indicates pin migration.

# ARRIA 10 SoC FEATURES

View device ordering codes on [page 39](#).

PRODUCT LINE		SX 160	SX 220	SX 270	SX 320	SX 480	SX 570	SX 660	
Resources	Part number reference	10AS016	10AS022	10AS027	10AS032	10AS048	10AS057	10AS066	
	LEs (K)	160	220	270	320	480	570	660	
	System Logic Elements (K)	210	288	354	419	629	747	865	
	ALMs	61,510	83,730	101,620	118,730	181,790	217,080	250,540	
	Registers	246,040	334,920	406,480	474,920	727,160	868,320	1,002,160	
	M20K memory blocks	440	588	750	891	1,438	1,800	2,133	
	M20K memory (Mb)	9	11	15	17	28	35	42	
	MLAB memory (Mb)	1.0	1.8	2.4	2.8	4.3	5.0	5.7	
	Hardened single-precision floating-point multipliers/ adders	156/156	191/191	830/830	985/985	1,368/1,368	1,523/1,523	1,688/1,688	
	18 x 19 multipliers	312	382	1,660	1,970	2,736	3,046	3,376	
	Peak fixed-point performance (GMACS) <sup>1</sup>	343	420	1,826	2,167	3,010	3,351	3,714	
	Peak floating-point performance (GFLOPS)	140	172	747	887	1,231	1,371	1,519	
Clocks, Maximum I/O Pins, and Architectural Features	Global clock networks	32	32	32	32	32	32	32	
	Regional clocks	8	8	8	8	8	8	16	
	I/O voltage levels supported (V)	1.2, 1.25, 1.35, 1.8, 2.5, 3.0							
	I/O standards supported	3 V I/O pins only: 3 V LVTTTL, 2.5 V CMOS DDR and LVDS I/O pins: POD12, POD10, Differential POD12, Differential POD10, LVDS, RSDS, mini-LVDS, LVPECL All I/Os: 1.8 V CMOS, 1.5 V CMOS, 1.2 V CMOS, SSTL-135, SSTL-125, SSTL-18 (1 and II), SSTL-15 (I and II), SSTL-12, HSTL-18 (I and II), HSTL-15 (I and II), HSTL-12 (I and II), HSUL-12, Differential SSTL-135, Differential SSTL-125, Differential SSTL-18 (I and II), Differential SSTL-15 (I and II), Differential SSTL-12, Differential HSTL-18 (I and II), Differential HSTL-15 (I and II), Differential HSTL-12 (I and II), Differential HSUL-12							
		Maximum LVDS channels (1.6 G)	120	120	168	168	222	270	270
		Maximum user I/O pins	288	288	384	384	492	696	696
	Transceiver count (17.4 Gbps)	12	12	24	24	36	48	48	
	Transceiver count (25.78 Gbps)	-	-	-	-	-	-	-	
	PCIe hardened IP blocks (Gen3 x8)	1	1	2	2	2	2	2	
	Maximum 3 V I/O pins	48	48	48	48	48	48	48	
Memory devices supported	DDR4, DDR3, DDR2, QDR IV, QDR II+, QDR II+ Xtreme, LPDDR3, LPDDR2, RLDRAM 3, RLDRAM II, LLD RAM II, HMC								
Package Options <sup>2</sup> and I/O Pins <sup>3</sup> : General-Purpose I/O (GPIO) Count, High-Voltage I/O Count, LVDS Pairs <sup>4</sup> , and Transceiver Count									
U19	U484 pin (19 mm)	192, 48, 72, 6	192, 48, 72, 6	-	-	-	-	-	
F27	F672 pin (27 mm)	240, 48, 96, 12	240, 48, 96, 12	240, 48, 96, 12	240, 48, 96, 12	-	-	-	
F29	F780 pin (29 mm)	288, 48, 120, 12	288, 48, 120, 12	360, 48, 156, 12	360, 48, 156, 12	360, 48, 156, 12	-	-	
F34	F1152 pin (35 mm)	-	-	384, 48, 168, 24	384, 48, 168, 24	492, 48, 222, 24	492, 48, 222, 24	492, 48, 222, 24	
F35	F1152 pin (35 mm)	-	-	384, 48, 168, 24	384, 48, 168, 24	396, 48, 174, 36	396, 48, 174, 36	396, 48, 174, 36	
KF40	F1517 pin (40 mm)	-	-	-	-	-	696, 96, 324, 36	696, 96, 324, 36	
NF40	F1517 pin (40 mm)	-	-	-	-	-	588, 48, 270, 48	588, 48, 270, 48	

- Notes:
- Fixed-point performance assumes the use of pre-adder.
  - All packages are ball grid arrays with 1.0 mm pitch, except for U19 (U484), which is 0.8 mm pitch.
  - A subset of pins for each package are used for 3.3 V and 2.5 V interfaces.
  - Each LVDS pair can be configured as either a differential input or a differential output.
  - Certain packages might not bond out all PCIe hard IP blocks.
  - All data is correct at the time of printing, and may be subject to change without prior notice. For the latest information, please visit [www.altera.com](http://www.altera.com).

192, 48, 72, 6 Numbers indicate GPIO count, high-voltage I/O count, LVDS pairs, and transceiver count.  
 Indicates pin migration.

HARD PROCESSOR SYSTEM (HPS)	
Processor	Dual-core ARM Cortex-A9 MPCore processor
Maximum processor frequency	1.5 GHz <sup>1</sup>
Processor cache and co-processors	<ul style="list-style-type: none"> <li>L1 instruction cache (32 KB)</li> <li>L1 data cache (32 KB)</li> <li>Level 2 cache (512 KB) shared</li> <li>FPU single and double precision</li> <li>ARM Neon media engine</li> <li>ARM CoreSight debug and trace technology</li> <li>Snoop control unit (SCU)</li> <li>Acceleration coherency port (ACP)</li> </ul>
Scratch pad RAM	256 KB
HPS DDR memory	DDR4 and DDR3 (Up to 64 bit with ECC)
DMA controller	8 channels
EMAC	3X 10/100/1000 EMAC with integrated DMA
USB OTG controller	2X USB OTG with integrated DMA
UART controller	2X UART 16550 compatible
SPI controller	4X SPI
I <sup>2</sup> C controller	5X I <sup>2</sup> C
Quad SPI flash controller	1X SIO, DIO, QIO SPI flash supported
SD/SDIO/MMC controller	1X eMMC 4.5 with DMA and CE-ATA support
NAND flash controller	<ul style="list-style-type: none"> <li>1X ONFI 1.0 or later</li> <li>8 and 16 bit support</li> </ul>
General-purpose timers	7X
Software-programmable GPIOs	Maximum 54 GPIOs
Direct shared I/Os	48 I/Os to connect HPS peripherals directly to I/O
Watchdog timers	4X
Security	Secure boot, AES, and secure hash algorithm

- Notes:
- With overdrive feature.

# MAX 10 FPGA OVERVIEW

MAX 10 FPGAs revolutionize non-volatile integration by delivering advanced processing capabilities in a low-cost, instant-on, small form factor, programmable logic device.

MAX 10 FPGAs are built on TSMC's 55 nm flash technology, enabling instant-on configuration so you can quickly control the power-up or initialization of other components in the system. The devices also include full-featured FPGA capabilities, such as DSP, analog functionality, Nios II Gen2 embedded soft processor support, and memory controllers.

With a robust set of FPGA capabilities, MAX 10 FPGAs are optimized for a wide range of high-volume, cost-sensitive applications, including:

## Automotive



- Built on TSMC's 55 nm high-volume flash process tailored for the automotive industry's rigorous safety and quality requirements
- Integrated flash provides instant-on behavior for applications requiring fast boot times such as rear-view cameras in advanced driver assistance systems (ADAS) and infotainment displays
- FPGA-class signal processing acceleration for electric vehicle (EV) applications, such as motor control, battery management, and power conversion

## Industrial



- Reduced footprint, increased design security and reliability, and lower system cost
- Accurate environmental condition sensing and efficient real-time controls for motor control, I/O modules, and Internet of Things (IoT) applications
- Single-chip support for multiple industrial Ethernet protocols and machine-to-machine (M2M) communication

## Communications



- Analog functionality for sensing board environment allows integration of power-up sequencing and system-monitoring circuitry in a single device
- High I/O count and software-based system management using the Nios II soft processor enable board management integration in an advanced, reliable, single-chip system controller

# MAX 10 FPGA FEATURES

View device ordering codes on [page 39](#).

PRODUCT LINE	10M02	10M04	10M08	10M16	10M25	10M40	10M50
LEs (K)	2	4	8	16	25	40	50
Block memory (Kb)	108	189	378	549	675	1,260	1,638
User flash memory <sup>1</sup> (KB)	12	16 – 156	32 – 172	32 – 296	32 – 400	64 – 736	64 – 736
18 x 18 multipliers	16	20	24	45	55	125	144
PLLs <sup>2</sup>	1, 2	1, 2	1, 2	1, 4	1, 4	1, 4	1, 4
Internal configuration	Single	Dual	Dual	Dual	Dual	Dual	Dual
Analog-to-digital converter (ADC), temperature sensing diode (TSD) <sup>3</sup>	-	1, 1	1, 1	1, 1	2, 1	2, 1	2, 1
External memory interface (EMIF)	Yes <sup>4</sup>	Yes <sup>4</sup>	Yes <sup>4</sup>	Yes <sup>5</sup>	Yes <sup>5</sup>	Yes <sup>5</sup>	Yes <sup>5</sup>

## Package Options and I/O Pins: Feature Set Options, GPIO, True LVDS Transceiver/Receiver

V36 (D) <sup>6</sup>	WLCSP (3 mm, 0.4 mm pitch)	C, 27, 3/7	-	-	-	-	-	-
V81 (D) <sup>7</sup>	WLCSP (4 mm, 0.4 mm pitch)	-	-	C/F, 56, 7/17	-	-	-	-
F256 (D)	FBGA (17 mm, 1.0 mm pitch)	-	C/A, 178, 13/54	C/A, 178, 13/54	C/A, 178, 13/54	C/A, 178, 13/54	C/A, 178, 13/54	C/A, 178, 13/54
U324 (D)	UBGA (15 mm, 0.8 mm pitch)	C, 160, 9/47	C/A, 246, 15/81	C/A, 246, 15/81	C/A, 246, 15/81	-	-	-
F484 (D)	FBGA (23 mm, 1.0 mm pitch)	-	-	C/A, 250, 15/83	C/A, 320, 22/116	C/A, 360, 24/136	C/A, 360, 24/136	C/A, 360, 24/136
F672 (D)	FBGA (27 mm, 1.0 mm pitch)	-	-	-	-	-	C/A, 500, 30/192	C/A, 500, 30/192
E144 (S) <sup>6</sup>	EQFP (22 mm, 0.5 mm pitch)	C, 101, 7/27	C/A, 101, 10/27	C/A, 101, 10/27	C/A, 101, 10/27	C/A, 101, 10/27	C/A, 101, 10/28	C/A, 101, 10/28
M153 (S)	MBGA (8 mm, 0.5 mm pitch) <sup>8</sup>	C, 112, 9/29	C/A, 112, 9/29	C/A, 112, 9/29	-	-	-	-
U169 (S)	UBGA (11 mm, 0.8 mm pitch)	C, 130, 9/38	C/A, 130, 9/38	C/A, 130, 9/38	C/A, 130, 9/38	-	-	-

### Notes:

- Additional user flash may be available, depending on configuration options.
- The number of PLLs available is dependent on the package option.
- Availability of the ADC or TSD varies by package type. Smaller pin-count packages do not have access to the ADC hard IP.
- SRAM only.
- SRAM, DDR3 SDRAM, DDR2 SDRAM, or LPDDR2.
- "D" = Dual power supply (1.2 V/2.5 V), "S" = Single power supply (3.3 V or 3.0 V).
- V81 package does not support analog feature set. 10M08 V81 F devices support dual image with RSU.
- "Easy PCB" utilizes 0.8 mm PCB design rules.
- All data is correct at the time of printing, and may be subject to change without prior notice. For the latest information, please visit [www.altera.com](http://www.altera.com).

**C, 27, 3/7** Indicates feature set options, GPIO count, and LVDS transmitter or receiver count. Feature set options: C = Compact (single image), F = Flash (dual image with RSU), A = Analog (analog features block). Each has added premiums.

■ — ■ Indicates pin migration.

# STRATIX V FPGA FEATURES

View device ordering codes on [page 39](#).

PRODUCT LINE		STRATIX V GS FPGAs <sup>1</sup>					STRATIX V GX FPGAs <sup>1</sup>										STRATIX V GT FPGAs <sup>1</sup>		STRATIX V E FPGAs <sup>1</sup>	
		5SGSD3	5SGSD4	5SGSD5	5SGSD6	5SGSD8	5SGXA3	5SGXA4	5SGXA5	5SGXA7	5SGXA9	5SGXAB	5SGXB5	5SGXB6	5SGXB9	5SGXBB	5SGTC5	5SGTC7	5SEE9	5SEEB
Resources	LEs (K)	236	360	457	583	695	340	420	490	622	840	952	490	597	840	952	425	622	840	952
	ALMs	89,000	135,840	172,600	220,000	262,400	128,300	158,500	185,000	234,720	317,000	359,200	185,000	225,400	317,000	359,200	160,400	234,720	317,000	359,200
	Registers	356,000	543,360	690,400	880,000	1,049,600	513,200	634,000	740,000	938,880	1,268,000	1,436,800	740,000	901,600	1,268,000	1,436,800	641,600	938,880	1,268,000	1,436,800
	M20K memory blocks	688	957	2,014	2,320	2,567	957	1,900	2,304	2,560	2,640	2,640	2,100	2,660	2,640	2,640	2,304	2,560	2,640	2,640
	M20K memory (Mb)	13	19	39	45	50	19	37	45	50	52	52	41	52	52	52	45	50	52	52
	MLAB memory (Mb)	2.72	4.15	5.27	6.71	8.01	3.92	4.84	5.65	7.16	9.67	10.96	5.65	6.88	9.67	10.96	4.9	7.16	9.67	10.96
	Variable-precision DSP blocks	600	1,044	1,590	1,775	1,963	256	256	256	256	352	352	399	399	352	352	256	256	352	352
	18 x 18 multipliers	1,200	2,088	3,180	3,550	3,926	512	512	512	512	704	704	798	798	704	704	512	512	704	704
Clocks, Maximum I/O Pins, and Architectural Features	Global clock networks	16	16	16	16	16	16	16	16	16	16	16	16	16	16	16	16	16	16	16
	Regional clocks	92	92	92	92	92	92	92	92	92	92	92	92	92	92	92	92	92	92	92
	I/O voltage levels supported (V)	1.2, 1.5, 1.8, 2.5, 3.3 <sup>2</sup>																		
	I/O standards supported	LVTTTL, LVCMOS, PCI*, PCI-X, LVDS, mini-LVDS, RSDS, LVPECL, SSTL-18 (I and II), SSTL-15 (I and II), SSTL-2 (I and II), HSTL-18 (I and II), HSTL-15 (I and II), HSTL-12 (I and II), Differential SSTL-18 (I and II), Differential SSTL-15 (I and II), Differential SSTL-2 (I and II), Differential HSTL-18 (I and II), Differential HSTL-15 (I and II), Differential HSTL-12 (I and II), Differential HSUL-12																		
Clocks, Maximum I/O Pins, and Architectural Features	LVDS channels, 1.4 Gbps (receive/transmit)	108	174	174	210	210	174	174	210	210	210	210	150	150	150	150	150	150	210	210
	Transceiver count (14.1 Gbps)	24	36	36	48	48	36	36	48	48	48	48	66	66	66	66	32	32	-	-
	Transceiver count (28.05 Gbps)	-	-	-	-	-	-	-	-	-	-	-	-	-	-	-	4	4	-	-
	PCIe hardened IP blocks (Gen3 x8)	1	1	1	4	4	2	2	4	4	4	4	4	4	4	4	1	1	-	-
	Memory devices supported	DDR3, DDR2, DDR, QDR II, QDR II+, RLD RAM II, RLD RAM 3																		

Package Options and I/O Pins: General-Purpose I/O (GPIO) Count, High-Voltage I/O Count, LVDS Pairs, and Transceiver Count

F780 pin (29 mm, 1.0 mm pitch)	360, 90, 12 <sup>3</sup>	360, 90, 12 <sup>3</sup>	-	-	-	360, 90, 12 <sup>3</sup>	-	-	-	-	-	-	-	-	-	-	-	-	-	-	
F1152 pin (35 mm, 1.0 mm pitch)	432, 108, 24	432, 108, 24	552, 138, 24	-	-	432, 108, 24	552, 138, 24	552, 138, 24	552, 138, 24	-	-	-	-	-	-	-	-	-	-	-	
F1152 pin (35 mm, 1.0 mm pitch)	-	-	-	-	-	432, 108, 36	432, 108, 36	432, 108, 36	432, 108, 36	-	-	-	-	-	-	-	-	-	-	-	
F1517 pin (40 mm, 1.0 mm pitch)	-	696, 174, 36	696, 174, 36	696, 174, 36	696, 174, 36	696, 174, 36	696, 174, 36	696, 174, 36	696, 174, 36	696, 174, 36 <sup>4</sup>	696, 174, 36 <sup>4</sup>	432, 108, 66	432, 108, 66	-	-	-	-	-	696, 174, 0 <sup>4</sup>	696, 174, 0 <sup>4</sup>	
F1517 pin (40 mm, 1.0 mm pitch)	-	-	-	-	-	-	-	600, 150, 48	600, 150, 48	-	-	-	-	-	-	-	-	600, 150, 36 <sup>5</sup>	600, 150, 36 <sup>5</sup>	-	-
F1760 pin (42.5 mm, 1.0 mm pitch)	-	-	-	-	-	-	-	-	-	-	-	600, 150, 66	600, 150, 66	600, 150, 66 <sup>4</sup>	600, 150, 66 <sup>4</sup>	-	-	-	-	-	
F1932 pin (45 mm, 1.0 mm pitch)	-	-	-	840, 210, 48	840, 210, 48	-	-	840, 210, 48	840, 210, 48	840, 210, 48	840, 210, 48	-	-	-	-	-	-	-	840, 210, 0	840, 210, 0	

- Notes:
- All data is correct at the time of printing, and may be subject to change without prior notice. For the latest information, please visit [www.altera.com](http://www.altera.com).
  - 3.3 V compliant, requires a 3.0 V power supply.
  - Hybrid package (flip chip) FBGA: 33 x 33 (mm) 1.0-mm pitch.
  - Hybrid package (flip chip) FBGA: 45 x 45 (mm) 1.0-mm pitch.
  - GX-GT migration. Unused transceiver channels connected to power/ground.
  - 360, 90, 12** Numbers indicate GPIO count, LVDS count, and transceiver count.
  -  Pin migration (same V<sub>cc</sub>, GND, ISP, and input pins). User I/O pins may be less than labelled for pin migration.
  - Stratix series devices are offered for commercial and industrial temperatures and RoHS-compliant packages. Stratix IV GT devices are only offered for industrial temperatures (0 °C to 100 °C).



# ARRIA V FPGA AND SoC FEATURES

View device ordering codes on [page 41](#).

PRODUCT LINE		ARRIA V GX FPGAs <sup>1</sup>								ARRIA V GT FPGAs <sup>1</sup>				ARRIA V GZ FPGAs <sup>1</sup>				ARRIA V SX SoCs <sup>1</sup>		ARRIA V ST SoCs <sup>1</sup>	
		5AGXA1	5AGXA3	5AGXA5	5AGXA7	5AGXB1	5AGXB3	5AGXB5	5AGXB7	5AGTC3	5AGTC7	5AGTD3	5AGTD7	5AGZE1	5AGZE3	5AGZE5	5AGZE7	5ASXB3	5ASXB5	5ASTD3	5ASTD5
Resources	LEs (K)	75	156	190	242	300	362	420	504	156	242	362	504	220	360	400	450	350	462	350	462
	ALMs	28,302	58,900	71,698	91,680	113,208	136,880	158,491	190,240	58,900	91,680	136,880	190,240	83,020	135,840	150,960	169,800	132,075	174,340	132,075	174,340
	Registers	113,208	235,600	286,792	366,720	452,832	547,520	633,964	760,960	235,600	366,720	547,520	760,960	332,080	543,360	603,840	679,200	528,300	697,360	528,300	697,360
	M10K memory blocks	800	1,051	1,180	1,366	1,510	1,726	2,054	2,414	1,051	1,366	1,726	2,414	-	-	-	-	1,729	2,282	1,729	2,282
	M20K memory blocks	-	-	-	-	-	-	-	-	-	-	-	-	585	957	1,440	1,700	-	-	-	-
	M10K memory (Kb)	8,000	10,510	11,800	13,660	15,100	17,260	20,540	24,140	10,510	13,660	17,260	24,140	-	-	-	-	17,290	22,820	17,290	22,820
	M20K memory (Kb)	-	-	-	-	-	-	-	-	-	-	-	-	11,700	19,140	28,800	34,000	-	-	-	-
	MLAB memory (Kb)	463	961	1,173	1,448	1,852	2,098	2,532	2,906	961	1,448	2,098	2,906	2,594	4,245	4,718	5,306	2,014	2,658	2,014	2,658
	Variable-precision DSP blocks	240	396	600	800	920	1,045	1,092	1,156	396	800	1,045	1,156	800	1,044	1,092	1,139	809	1,090	809	1,090
18 x 18 multipliers	480	792	1,200	1,600	1,840	2,090	2,184	2,312	792	1,600	2,090	2,312	1,600	2,088	2,184	2,278	1,618	2,180	1,618	2,180	
Clocks, Maximum I/O Pins, and Architectural Features	Processor cores (ARM Cortex-A9)	-	-	-	-	-	-	-	-	-	-	-	-	-	-	-	-	Dual	Dual	Dual	Dual
	Maximum CPU clock frequency (GHz)	-	-	-	-	-	-	-	-	-	-	-	-	-	-	-	-	1.05 <sup>2</sup>	1.05 <sup>2</sup>	1.05 <sup>2</sup>	1.05 <sup>2</sup>
	Global clock networks	16	16	16	16	16	16	16	16	16	16	16	16	16	16	16	16	16	16	16	16
	PLLs <sup>3</sup> (FPGA)	10	10	12	12	12	12	16	16	10	12	12	16	20	20	24	24	14	14	14	14
	PLLs (HPS)	-	-	-	-	-	-	-	-	-	-	-	-	-	-	-	-	3	3	3	3
	I/O voltage levels supported (V)	1.2, 1.5, 1.8, 2.5, 3.0, 3.3 <sup>4</sup>																			
	I/O standards supported	LVTTTL, LVCMOS, PCI, PCI-X, LVDS, mini-LVDS, RSDS, LVPECL, SSTL-18 (I and II), SSTL-15 (I and II), SSTL-2 (I and II), HSTL-18 (I and II), HSTL-15 (I and II), HSTL-12 (I and II), Differential SSTL-18 (I and II), Differential SSTL-15 (I and II), Differential SSTL-2 (I and II), Differential HSTL-18 (I and II), Differential HSTL-15 (I and II), Differential HSTL-12 (I and II), Differential HSUL-12																			
	LVDS channels (receiver/transmitter)	80/67	80/67	136/120	136/120	176/160	176/160	176/160	176/160	80/70	136/120	176/160	176/160	108/99	108/99	168/166	168/166	136/120	136/120	136/120	136/120
	Transceiver count (6.5536 Gbps)	9	9	24	24	24	24	36	36	3	6	6	6	-	-	-	-	30	30	30	30
	Transceiver count (10.3125 Gbps) <sup>5</sup>	-	-	-	-	-	-	-	-	4	12	12	20	-	-	-	-	-	-	16	16
	Transceiver count (12.5 Gbps)	-	-	-	-	-	-	-	-	-	-	-	-	24	24	36	36	-	-	-	-
	PCIe hardened IP blocks (Gen2 x4)	1	1	2	2	2	2	2	2	1	2	2	2	-	-	-	-	2	2	2	2
	PCIe hardened IP blocks (Gen2 x8, Gen3)	-	-	-	-	-	-	-	-	-	-	-	-	1	1	1	1	-	-	-	-
	GPIOs (FPGA)	-	-	-	-	-	-	-	-	-	-	-	-	-	-	-	-	540	540	540	540
	GPIOs (HPS)	-	-	-	-	-	-	-	-	-	-	-	-	-	-	-	-	208	208	208	208
	Hard memory controllers <sup>6</sup> (FPGA)	2	2	4	4	4	4	4	4	2	4	4	4	-	-	-	-	3	3	3	3
	Hard memory controllers (HPS)	-	-	-	-	-	-	-	-	-	-	-	-	-	-	-	-	1	1	1	1
Memory devices supported	DDR3, DDR2, DDR II <sup>7</sup> , QDR II, QDR II+, RLD RAM II, RLD RAM 3 <sup>8</sup> , LPDDR <sup>7</sup> , LPDDR2 <sup>7</sup>																				

Package Options and I/O Pins: GPIO Count, High-Voltage I/O Count, LVDS Pairs, and Transceiver Count

F672 pin (27 mm, 1.0 mm pitch)	336 9,0	336 9,0	336 9,0	336 9,0	-	-	-	-	336 3,4	-	-	-	-	-	-	-	-	-	-	-
H780 pin (29 mm, 1.0 mm pitch)	-	-	-	-	-	-	-	-	-	-	-	-	342 12	342 12	-	-	-	-	-	-
F896 pin (31 mm, 1.0 mm pitch)	416 9,0	416 9,0	384 18,0	384 18,0	384 18,0	384 18,0	-	-	416 3,4	384 6,8	384 6,8	-	-	-	-	-	250, 208 12+0	250, 208 12+0	250, 208 12+6	250, 208 12+6
F896 pin (31 mm, 1.0 mm pitch)	320 9,0	320 9,0	320 9,0	320 9,0	320 9,0	-	-	-	320 3,4	320 3,4	320 3,4	-	-	-	-	-	-	-	-	-
F1152 pin (35 mm, 1.0 mm pitch)	-	-	544 24,0	544 24,0	544 24,0	544 24,0	544 24,0	544 24,0	-	544 6,12	544 6,12	544 6,12	414 24	414 24	534 24	534 24	385, 208 18+0	385, 208 18+0	385, 208 18+8	385, 208 18+8
F1517 pin (40 mm, 1.0 mm pitch)	-	-	-	-	704 24,0	704 24,0	704 36,0	704 36,0	-	-	704 6,12	704 6,20	-	-	674 36	674 36	540, 208 30+0	540, 208 30+0	540, 208 30+16	540, 208 30+16

Notes:

- All data is correct at the time of printing, and may be subject to change without prior notice. For the latest information, please visit [www.altera.com](http://www.altera.com).
- 1.15 V operation.
- The PLL count includes general-purpose fractional PLLs and transceiver fractional PLLs.
- For Arria V GZ devices, the I/O voltage of 3.3 V compliant, requires a 3.0 V power supply.
- One pair of 10 Gbps transceiver channels can be configured as three 6 Gbps transceiver channels.
- With 16 and 32 bit ECC support.
- These memory interfaces are not available as Intel FPGA IP.
- This memory interface is only available for Arria V GZ devices.

**336  
9,0** For Arria V GX and GT devices, values on top indicate available user I/O pins and values at the bottom indicate the 6.5536 Gbps and 10.3125 Gbps transceiver count. One pair of 10 Gbps transceiver channels can be configured as three 6 Gbps transceiver channels. For Arria V GZ devices, values on top indicate available user I/O pins and values at the bottom indicate the 12.5 Gbps transceiver count.

**250, 208  
12+0** Values on top indicate available FPGA user I/O pins and HPS I/O pins; values at the bottom indicate the 6.5536 Gbps plus 10.3125 Gbps transceiver count.

 Pin migration (same V<sub>cc</sub>, GND, ISP, and input pins). User I/O pins may be less than labelled for pin migration.

 Pin migration is only possible if you use up to 320 I/O pins, up to nine 6.5536 Gbps transceiver count (for Arria V GX devices), and up to four 10.3125 Gbps transceiver count (for Arria V GT devices).

# CYCLONE V FPGA FEATURES

View device ordering codes on [page 41](#).

PRODUCT LINE		CYCLONE V E FPGAS <sup>1</sup>					CYCLONE V GX FPGAS <sup>1</sup>					CYCLONE V GT FPGAS <sup>1</sup>		
		5CEA2	5CEA4	5CEA5	5CEA7	5CEA9	5CGXC3	5CGXC4	5CGXC5	5CGXC7	5CGXC9	5CGTD5	5CGTD7	5CGTD9
Resources	LEs (K)	25	49	77	149.5	301	35.5	50	77	149.5	301	77	149.5	301
	ALMs	9,434	18,480	29,080	56,480	113,560	13,460	18,868	29,080	56,480	113,560	29,080	56,480	113,560
	Registers	37,736	73,920	116,320	225,920	454,240	53,840	75,472	116,320	225,920	454,240	116,320	225,920	454,240
	M10K memory blocks	176	308	446	686	1,220	135	250	446	686	1,220	446	686	1,220
	M10K memory (Kb)	1,760	3,080	4,460	6,860	12,200	1,350	2,500	4,460	6,860	12,200	4,460	6,860	12,200
	MLAB memory (Kb)	196	303	424	836	1,717	291	295	424	836	1,717	424	836	1,717
	Variable-precision DSP blocks	25	66	150	156	342	57	70	150	156	342	150	156	342
	18 x 18 multipliers	50	132	300	312	684	114	140	300	312	684	300	312	684
Clocks, Maximum I/O Pins, and Architectural Features	Global clock networks	16	16	16	16	16	16	16	16	16	16	16	16	16
	PLLs <sup>2</sup> (FPGA)	4	4	6	7	8	4	6	6	7	8	6	7	8
	I/O voltage levels supported (V)	1.1, 1.2, 1.5, 1.8, 2.5, 3.3												
	I/O standards supported	LVTTTL, LVCMOS, PCI, PCI-X, LVDS, mini-LVDS, RSDS, LVPECL, SSTL-18 (I and II), SSTL-15 (I and II), SSTL-2 (I and II), HSTL-18 (I and II), HSTL-15 (I and II), HSTL-12 (I and II), Differential SSTL-18 (I and II), Differential SSTL-15 (I and II), Differential SSTL-2 (I and II), Differential HSTL-18 (I and II), Differential HSTL-15 (I and II), Differential HSTL-12 (I and II), Differential HSUL-12, HiSpi, SLVS, Sub-LVDS												
	LVDS channels (receiver/transmitter)	56/56	56/56	60/60	120/120	120/120	52/52	84/84	84/84	120/120	140/140	84/84	120/120	140/140
	Transceiver count (3.125 Gbps)	–	–	–	–	–	3	6	6	9	12	–	–	–
	Transceiver count (6.144 Gbps) <sup>3</sup>	–	–	–	–	–	–	–	–	–	–	6 <sup>4</sup>	9 <sup>4</sup>	12 <sup>4</sup>
	PCIe hardened IP blocks (Gen1)	–	–	–	–	–	1	2	2	2	2	–	–	–
	PCIe hardened IP blocks (Gen2)	–	–	–	–	–	–	–	–	–	–	2	2	2
	Hard memory controllers <sup>5</sup> (FPGA)	1	1	2	2	2	1	2	2	2	2	2	2	2
	Memory devices supported	DDR3, DDR2, LPDDR2												

Package Options and I/O Pins: GPIO Count, High-Voltage I/O Count, LVDS Pairs, and Transceiver Count

M301 pin (11 mm, 0.5 mm pitch)																	129 4	129 4									129 4			
M383 pin (13 mm, 0.5 mm pitch)	223	223	175														175 6	175 6									175 6			
M484 pin (15 mm, 0.5 mm pitch)				240										240 3													240 3			
U324 pin (15 mm, 0.8 mm pitch)	176	176												144 3																
U484 pin (19 mm, 0.8 mm pitch)	224	224	224	240	240									208 3	224 6	224 6	240 6	240 5									224 6	240 6	240 5	
F256 pin (17 mm, 1.0 mm pitch)	128	128																												
F484 pin (23 mm, 1.0 mm pitch)	224	224	240	240	224									208 3	240 6	240 6	240 6	224 6									240 6	240 6	224 6	
F672 pin (27 mm, 1.0 mm pitch)				336	336										336 6	336 6	336 9	336 9									336 6	336 9	336 9	
F896 pin (31 mm, 1.0 mm pitch)				480	480																							480 9	480 12	480 12
F1152 pin (35 mm, 1.0 mm pitch)																												560 12	560 12	

- Notes:
1. All data is correct at the time of printing, and may be subject to change without prior notice. For the latest information, please visit [www.altera.com](http://www.altera.com).
  2. The PLL count includes general-purpose fractional PLLs and transceiver fractional PLLs.
  3. Automotive grade Cyclone V GT FPGAs include a 5 Gbps transceiver.
  4. Transceiver counts shown are for ≤ 5 Gbps. The 6 Gbps channel count support depends on package and channel usage. Refer to [Cyclone V Device Handbook Volume 2: Transceivers](#) for guidelines.
  5. Includes 16 and 32 bit error correction code ECC support.

129  
4 Values on top indicate available user I/O pins; values at the bottom indicate the 3.125 Gbps, 5 Gbps, or 6.144 Gbps transceiver count.

—■ Pin migration (same V<sub>cc</sub>, GND, ISP, and input pins). User I/O pins may be less than labelled for pin migration.

—■ For FPGAs: Pin migration is only possible if you use only up to 175 GPIOs.

# CYCLONE V SoC FEATURES

View device ordering codes on [page 41](#).

PRODUCT LINE	CYCLONE V SE SoCs <sup>1</sup>				CYCLONE V SX SoCs <sup>1</sup>				CYCLONE V ST SoCs <sup>1</sup>		
	5CSEA2	5CSEA4	5CSEA5	5CSEA6	5CSXC2	5CSXC4	5CSXC5	5CSXC6	5CSTD5	5CSTD6	
Resources	LEs (K)	25	40	85	110	25	40	85	110	85	110
	ALMs	9,434	15,094	32,075	41,509	9,434	15,094	32,075	41,509	32,075	41,509
	Registers	37,736	60,376	128,300	166,036	37,736	60,376	128,300	166,036	128,300	166,036
	M10K memory blocks	140	270	397	557	140	270	397	557	397	557
	M10K memory (Kb)	1,400	2,700	3,970	5,570	1,400	2,700	3,970	5,570	3,970	5,570
	MLAB memory (Kb)	138	231	480	621	138	231	480	621	480	621
	Variable-precision DSP blocks	36	84	87	112	36	84	87	112	87	112
	18 x 18 multipliers	72	168	174	224	72	168	174	224	174	224
Clocks, Maximum I/O Pins, and Architectural Features	Processor cores (ARM Cortex-A9)	Single or dual	Single or dual	Single or dual	Single or dual	Dual	Dual	Dual	Dual	Dual	Dual
	Maximum CPU clock frequency (MHz)	925	925	925	925	925	925	925	925	925	925
	Global clock networks	16	16	16	16	16	16	16	16	16	16
	PLLs <sup>2</sup> (FPGA)	5	5	6	6	5	5	6	6	6	6
	PLLs (HPS)	3	3	3	3	3	3	3	3	3	3
	I/O voltage levels supported (V)	1.1, 1.2, 1.5, 1.8, 2.5, 3.3									
	I/O standards supported	LVTTTL, LVCMOS, PCI, PCI-X, LVDS, mini-LVDS, RSDS, LVPECL, SSTL-18 (I and II), SSTL-15 (I and II), SSTL-2 (I and II), HSTL-18 (I and II), HSTL-15 (I and II), HSTL-12 (I and II), Differential SSTL-18 (I and II), Differential SSTL-15 (I and II), Differential SSTL-2 (I and II), Differential HSTL-18 (I and II), Differential HSTL-15 (I and II), Differential HSTL-12 (I and II), Differential HSUL-12, HiSpi, SLVS, Sub-LVDS									
	LVDS channels (receiver/transmitter)	37/32	37/32	72/72	72/72	37/32	37/32	72/72	72/72	72/72	72/72
	Transceiver count (3.125 Gbps)	-	-	-	-	6	6	9	9	-	-
	Transceiver count (6.144 Gbps) <sup>3</sup>	-	-	-	-	-	-	-	-	9 <sup>4</sup>	9 <sup>4</sup>
	PCIe hardened IP blocks (Gen1)	-	-	-	-	2	2	2 <sup>5</sup>	2 <sup>5</sup>	-	-
	PCIe hardened IP blocks (Gen2)	-	-	-	-	-	-	-	-	2	2
	GPIOs (FPGA)	145	145	288	288	145	145	288	288	288	288
	GPIOs (HPS)	181	181	181	181	181	181	181	181	181	181
Hard memory controllers <sup>6</sup> (FPGA)	1	1	1	1	1	1	1	1	1	1	
Hard memory controllers <sup>6</sup> (HPS)	1	1	1	1	1	1	1	1	1	1	
Memory devices supported	DDR3, DDR2, LPDDR2										

Package Options and I/O Pins: General-Purpose I/O (GPIO) Count, High-Voltage I/O Count, LVDS Pairs, and Transceiver Count

U484 pin (19 mm, 0.8 mm pitch)	66, 151 0	66, 151 0	66, 151 0	66, 151 0						
U672 pin (23 mm, 0.8 mm pitch)	145, 181 0	145, 181 0	145, 181 0	145, 181 0	145, 181 6	145, 181 6	145, 181 6	145, 181 6		
F896 pin (31 mm, 1.0 mm pitch)			288, 181 0	288, 181 0			288, 181 9	288, 181 9	288, 181 9	288, 181 9

Notes:

- All data is correct at the time of printing, and may be subject to change without prior notice. For the latest information, please visit [www.altera.com](http://www.altera.com).
- The PLL count includes general-purpose fractional PLLs and transceiver fractional PLLs.
- Automotive grade Cyclone V GT FPGAs include a 5 Gbps transceiver.
- Transceiver counts shown are for ≤ 5 Gbps.  
The 6 Gbps channel count support depends on package and channel usage. Refer to [Cyclone V Device Handbook Volume 2: Transceivers for guidelines](#).
- One PCIe hard IP block in U672 package.
- With 16 and 32 bit ECC support.

66, 151  
0 Values on top indicate available FPGA user I/O pins and HPS I/O pins; values at the bottom indicate the 3.125 Gbps or 5 Gbps transceiver count.

Pin migration (same V<sub>cc</sub>, GND, ISP, and input pins). User I/O pins may be less than labelled for pin migration.

For SoCs: Pin migration is only possible if you use only up to 138 GPIOs.

# STRATIX IV FPGA FEATURES

View device ordering codes on [page 42](#).

PRODUCT LINE	STRATIX IV GX FPGAS <sup>1</sup>							STRATIX IV GT FPGAS <sup>1</sup>						STRATIX IV E FPGAS <sup>1</sup>				
	EP4SGX70	EP4SGX110	EP4SGX180	EP4SGX230	EP4SGX290	EP4SGX360	EP4SGX530	EP4S40G2	EP4S40G5	EP4S100G2	EP4S100G3	EP4S100G4	EP4S100G5	EP4SE230	EP4SE360	EP4SE530	EP4SE820	
Resources	LEs (K)	73	106	176	228	291	354	531	228	531	228	291	354	531	228	354	531	813
	ALMs	29,040	42,240	70,300	91,200	116,480	141,440	212,480	91,200	212,480	91,200	116,480	141,440	212,480	91,200	141,440	212,480	325,220
	Registers <sup>2</sup>	58,080	84,480	140,600	182,400	232,960	282,880	424,960	182,400	424,960	182,400	232,960	282,880	424,960	182,400	282,880	424,960	650,440
	M9K memory blocks	462	660	950	1,235	936	1,248	1,280	1,235	1,280	1,235	936	1,248	1,280	1,235	1,248	1,280	1,610
	M144K memory blocks	16	16	20	22	36	48	64	22	64	22	36	48	64	22	48	64	60
	MLAB memory (Kb)	908	1,320	2,197	2,850	3,640	4,420	6,640	2,850	6,640	2,850	3,640	4,420	6,640	2,850	4,420	6,640	10,163
	Embedded memory (Kb)	6,462	8,244	11,430	14,283	13,608	18,144	20,736	14,283	20,736	14,283	13,608	18,144	20,736	14,283	18,144	20,736	23,130
	18 x 18 multipliers	384	512	920	1,288	832	1,040 <sup>3</sup>	1,024	1,288	1,024	1,288	832	1,024	1,024	1,288	1,040	1,024	960
Clocks, Maximum I/O Pins, and Architectural Features	Global clock networks	16	16	16	16	16	16	16	16	16	16	16	16	16	16	16	16	16
	Regional clock networks	64	64	64	64	88	88	88	64	88	64	88	88	64	88	88	88	88
	Periphery clock networks	56	56	88	88	88	88	112	88	112	88	112	112	88	88	112	112	132
	PLLs	4	4	8	8	12	12	12	8	8	8	12	12	4	12	12	12	12
	I/O voltage levels supported (V)	1.2, 1.5, 1.8, 2.5, 3.3 <sup>4</sup>																
	I/O standards supported	LVTTTL, LVCMOS, PCI, PCI-X, LVDS, mini-LVDS, RSDS, LVPECL, SSTL-18 (I and II), SSTL-15 (I and II), SSTL-2 (I and II), HSTL-18 (I and II), HSTL-15 (I and II), HSTL-12 (I and II), Differential SSTL-18 (I and II), Differential SSTL-15 (I and II), Differential SSTL-2 (I and II), Differential SSTL-2 (I and II), Differential HSTL-18 (I and II), Differential HSTL-15 (I and II), Differential HSTL-12 (I and II), Differential HSUL-12																
	Emulated LVDS channels, 1.100 Mbps	128	128	192	192	256	256	256	192	256	192	256	256	256	128	256	256	288
	LVDS channels, 1,600 Mbps (receive/transmit)	56/56	56/56	88/88	88/88	98/98	98/98	98/98	46/46	46/46	46/46	46/46	46/46	46/46	56/56	88/88	112/112	132/132
	Transceiver count <sup>5</sup> (11.3 Gbps)	-	-	-	-	-	-	-	12	12	24	24	24	32	-	-	-	-
	Transceiver count (8.5 Gbps)	16	16	24	24	32	32	32	12	12	-	8	8	-	-	-	-	-
Transceiver count (6.5 Gbps)	8	8	12	12	16	16	16	12	12	12	16	16	16	-	-	-	-	
PCIe hardened IP blocks	2	2	2	2	4	4	4	2	2	2	4	4	4	-	-	-	-	
Memory devices supported	DDR3, DDR2, DDR, QDR II, QDR II+, RDRAM 2, SDR																	

Package Options and I/O Pins: General-Purpose I/O (GPIO) Count, High-Voltage I/O Count, LVDS Pairs, and Transceiver Count

F780 pin (29 mm, 1.0 mm pitch)	368 8+0	368 8+0	368 8+0	368 8+0	288 <sup>6</sup> 16+0	288 <sup>6</sup> 16+0	-	-	-	-	-	-	-	-	-	480	480
F1152 pin (35 mm, 1.0 mm pitch)	-	368 16+0	560 16+0	560 16+0	560 16+0	560 16+0	-	-	-	-	-	-	-	736 <sup>7</sup>	736 <sup>7</sup>	736	-
F1152 pin (35 mm, 1.0 mm pitch)	480 16+8	480 16+8	560 16+8	560 16+8	560 16+8	560 16+8	560 <sup>7</sup> 16+8	-	-	-	-	-	-	-	-	-	-
F1517 pin (40 mm, 1.0 mm pitch)	-	-	736 24+12	736 24+12	736 24+12	736 24+12	736 <sup>7</sup> 24+12	646 12+12+12	646 12+12+12	646 12+0+12	-	-	646 <sup>7</sup> 12+0+12	960 <sup>7</sup>	960 <sup>7</sup>	-	-
F1760 pin (42.5 mm, 1.0 mm pitch)	-	-	-	-	864 24+12	864 24+12	864 24+12	-	-	-	-	-	-	1,104	960	-	-
F1932 pin (45 mm, 1.0 mm pitch)	-	-	-	-	904 32+16	904 32+16	904 32+16	-	-	-	769 24+8+16	769 24+8+16	769 32+0+16	-	-	-	-

- Notes:
- All data is correct at the time of printing, and may be subject to change without prior notice. For the latest information, please visit [www.altera.com](http://www.altera.com).
  - The base core logic register count is shown. The ALM can support three registers when used in LUTREG mode, which increases the total register count by an additional 50%.
  - The EP4SGX360N device has 1,024 18 x 18 multipliers.
  - 3.3 V compliant, requires a 3.0 V power supply.
  - The total transceiver count is the sum of the 11.3, 8.5, and 6.5 Gbps transceivers.
  - Hybrid package (flip chip) FBGA: 35 x 35 (mm) 1.0 mm pitch.
  - Hybrid package (flip chip) FBGA: 42.5 x 42.5 (mm) 1.0 mm pitch.

**368  
8+0** Values on top indicate available user I/O pins; values at the bottom indicate the sum of 8.5 and 6.5 Gbps transceiver count.

**646  
12+12+12** Values on top indicate available user I/O pins; values on bottom indicate the sum of 11.3, 8.5, and 6.5 Gbps transceiver count.

 Pin migration (same Vcc, GND, ISP, and input pins). User I/Os may be less than labelled for pin migration.

Stratix series devices are offered for commercial and industrial temperatures and RoHS-compliant packages. Stratix IV GT devices are only offered for industrial temperatures (0°C to 100°C).

# ARRIA II GZ AND GX FPGA FEATURES

View device ordering codes on [page 42](#).

PRODUCT LINE		ARRIA II GZ FPGAS <sup>1</sup>			ARRIA II GX FPGAS <sup>1</sup>					
		EP2AGZ225	EP2AGZ300	EP2AGZ350	EP2AGX45	EP2AGX65	EP2AGX95	EP2AGX125	EP2AGX190	EP2AGX260
Resources	LEs (K)	224	298	349	43	60	89	118	118	244
	ALMs	89,600	119,200	139,400	18,050	25,300	37,470	49,640	76,120	102,600
	Registers <sup>2</sup>	179,200	238,400	278,800	36,100	50,600	74,940	99,280	152,240	205,200
	M9K memory blocks	1,235	1,248	1,248	319	495	612	730	840	950
	M144K memory blocks	0	24	36	–	–	–	–	–	–
	MLAB memory (Kb)	2,850	4,420	4,420	564	791	1,171	1,551	2,379	3,206
	Embedded memory (Kb)	11,115	14,688	16,416	2,871	4,455	5,508	6,570	7,560	8,550
	18 x 18 multipliers	800	920	1,040	232	312	448	576	656	736
Clocks, Maximum I/O Pins, and Architectural Features	Global clock networks	16	16	16	16	16	16	16	16	16
	Regional clock networks	64	88	88	48	48	48	48	48	48
	Periphery clock networks	88	88	88	50	50	59	59	84	84
	PLLs	8	8	8	4	4	6	6	6	6
	I/O voltage levels supported (V)	1.2, 1.5, 1.8, 2.5, 3.0, 3.3								
	I/O standards supported	LVTTTL, LVCMOS, PCI, PCI-X, LVDS, mini-LVDS, RSDS, LVPECL, SSTL-18 (I and II), SSTL-15 (I and II), SSTL-2 (I and II), HSTL-18 (I and II), HSTL-15 (I and II), HSTL-12 (I and II), Differential SSTL-18 ((I and II), Differential SSTL-15 (I and II), Differential SSTL-2 (I and II), Differential HSTL-18 (I and II), Differential HSTL-15 (I and II), Differential HSTL-12 (I and II), Differential HSUL-12								
	Emulated LVDS channels, 945 Mbps	–	–	–	56	56	64	64	96	96
	Emulated LVDS channels, 1.152 Mbps	184	184	184	–	–	–	–	–	–
	LVDS channels, 1,250 Mbps (receive/transmit)	Up to 86	Up to 86	Up to 86	85/84	85/84	105/104	105/104	145/144	145/144
	Transceiver count (6.375 Gbps)	Up to 24	Up to 24	Up to 24	8	8	12	12	16	16
PCIe hardened IP blocks (Base specification, Rev 1.1, 2.0, and so on)	1	1	1	1	1	1	1	1	1	
Memory devices supported	DDR3, DDR2, DDR, QDR II, RDRAM 2, SDR									

Package Options and I/O Pins: General-Purpose I/O (GPIO) Count, High-Voltage I/O Count, LVDS Pairs, and Transceiver Count

U358 pin (17 mm, 0.8 mm pitch)	–	–	–	156 4	156 4	–	–	–	–
F572 pin (25 mm, 1.0 mm pitch)	–	–	–	252 8	252 8	260 8	260 8	–	–
F780 pin (29 mm, 1.0 mm pitch)	–	–	–	364 8	364 8	372 12	372 12	372 12	372 12
Hybrid F780 pin (33 mm, 1.0 mm pitch)	–	281 16	281 16	–	–	–	–	–	–
F1152 pin (35 mm, 1.0 mm pitch)	554 16	554 16	554 16	–	–	–	–	–	–
F1517 pin (40 mm, 1.0 mm pitch)	734 24	734 24	734 24	–	–	–	–	–	–

- Notes:
- All data is correct at the time of printing, and may be subject to change without prior notice. For the latest information, please visit [www.altera.com](http://www.altera.com).
  - The base core logic register count is shown. The ALM can support three registers when used in LUTREG mode, which increases the total register count by an additional 50%.

 Values on top indicate available user I/O pins; values at the bottom indicate the 6.375 Gbps transceiver count.

 Pin migration (same Vcc, GND, ISP, and input pins). User I/Os may be less than labelled for pin migration.

# CYCLONE IV GX AND E FPGA FEATURES

View device ordering codes on [page 42](#).



PRODUCT LINE		CYCLONE IV GX FPGAS <sup>1</sup>							CYCLONE IV E FPGAS <sup>1</sup>								
		EP4CGX15	EP4CGX22	EEP4CGX30	EP4CGX50	EP4CGX75	EP4CGX110	EP4CGX150	EP4CE6	EP4CE10	EP4CE15	EP4CE22	EP4CE30	EP4CE40	EP4CE55	EP4CE75	EP4CE115
Resources	LEs (K)	14	21	29	50	74	109	150	6	10	15	22	29	40	56	75	114
	M9K memory blocks	60	84	120	278	462	666	720	30	46	56	66	66	126	260	305	432
	Embedded memory (Kb)	540	756	1,080	2,502	4,158	5,490	6,480	270	414	504	594	594	1,134	2,340	2,745	3,888
	18 x 18 multipliers	0	40	80	140	198	280	360	15	23	56	66	66	116	154	200	266
Clocks, Maximum I/O Pins, and Architectural Features	Global clock networks	20	20	20	30	30	30	30	10	10	20	20	20	20	20	20	20
	PLLs	3	4	4	8	8	8	8	2	2	4	4	4	4	4	4	4
	I/O voltage levels supported (V)	1.2, 1.5, 1.8, 2.5, 3.3															
	I/O standards supported	LVTTTL, LVCMOS, PCI, PCI-X, LVDS, mini-LVDS, RSDS, LVPECL, SSTL-18 (I and II), SSTL-15 (I and II), SSTL-2 (I and II), HSTL-18 (I and II), HSTL-15 (I and II), HSTL-12 (I and II), Differential SSTL-18 (I and II), Differential SSTL-15 (I and II), Differential SSTL-2 (I and II), Differential HSTL-18 (I and II), Differential HSTL-15 (I and II), Differential HSTL-12 (I and II), Differential HSUL-12															
	Emulated LVDS channels	9	40	40	73	73	139	139	66	66	137	52	224	224	160	178	230
	LVDS channels, 840 Mbps (receive/transmit)	7/7	14/14	14/14	49/49	49/49	59/59	59/59	-	-	-	-	-	-	-	-	-
	Transceiver count <sup>2</sup> (2.5 Gbps/3.124 Gbps)	2/0	2, 0 / 4, 0	4, 0 / 0, 4 <sup>3</sup>	0, 8	0, 8	0, 8	0, 8	-	-	-	-	-	-	-	-	-
	PCIe hardened IP blocks (Base specification, Rev 1.1, 2.0, and so on)	1	1	1	1	1	1	1	-	-	-	-	-	-	-	-	-
	Memory devices supported	DDR2, DDR, SDR															

Package Options and I/O Pins: General-Purpose I/O (GPIO) Count, High-Voltage I/O Count, LVDS Pairs, and Transceiver Count

E144 pin <sup>4</sup> (22 mm, 0.5 mm pitch)	-	-	-	-	-	-	-	-	91	91	81	79	-	-	-	-	-
M164 pin (8 mm, 0.5 mm pitch)	-	-	-	-	-	-	-	-	-	-	74	-	-	-	-	-	-
U256 pin (14 mm, 0.8 mm pitch)	-	-	-	-	-	-	-	-	179	179	165	153	-	-	-	-	-
U484 pin (19 mm, 0.8 mm pitch)	-	-	-	-	-	-	-	-	-	-	-	-	-	328	324	292	-
F169 pin (14 mm, 1.0 mm pitch)	72 2	72 2	72 2	-	-	-	-	-	-	-	-	-	-	-	-	-	-
F256 pin (17 mm, 1.0 mm pitch)	-	-	-	-	-	-	-	-	179	179	165	153	-	-	-	-	-
F324 pin (19 mm, 1.0 mm pitch)	-	150 4	150 4	-	-	-	-	-	-	-	-	-	193	193	-	-	-
F484 pin (23 mm, 1.0 mm pitch)	-	-	290 4	290 4	290 4	270 4	270 4	-	-	-	343	-	328	328	324	292	280
F672 pin (27 mm, 1.0 mm pitch)	-	-	-	310 8	310 8	393 8	393 8	-	-	-	-	-	-	-	-	-	-
F780 pin (29 mm, 1.0 mm pitch)	-	-	-	-	-	-	-	-	-	-	-	-	532	532	374	426	528
F896 pin (31 mm, 1.0 mm pitch)	-	-	-	-	-	475 8	475 8	-	-	-	-	-	-	-	-	-	-

Notes:

- All data is correct at the time of printing, and may be subject to change without prior notice. For the latest information, please visit [www.altera.com](http://www.altera.com).
- Transceiver performance varies by product line and package offering.
- EP4CGX30 supports 3.125 Gbps transceivers only in F484 package option.
- Enhanced thin quad flat pack (EQFP).

 Values on top indicate available user I/O pins; values at the bottom indicate the 2.5 Gbps or 3.125 Gbps transceiver count.  
 Pin migration (same Vcc, GND, ISP, and input pins). User I/Os may be less than labelled for pin migration.

# CYCLONE III AND CYCLONE III LS FPGA FEATURES

View device ordering codes on [page 42](#).

PRODUCT LINE		CYCLONE III FPGAS <sup>1</sup>							CYCLONE III LS FPGAS <sup>1</sup>				
		EP3C5	EP3C10	EP3C16	EP3C25	EP3C40	EP3C55	EP3C80	EP3C120	EP3CLS70	EP3CLS100	EP3CLS150	EP3CLS200
Resources	LEs (K)	5	10	15	25	40	56	81	119	70	100	151	198
	M9K memory blocks	46	46	56	66	126	260	305	432	333	483	666	891
	Embedded memory (Kb)	414	414	504	594	1,134	2,340	2,745	3,888	2,997	4,347	5,994	8,019
	18 x 18 multipliers	23	23	56	66	126	156	244	288	200	276	320	396
Clocks, Maximum I/O Pins, and Architectural Features	Global clock networks	10	10	20	20	20	20	20	20	20	20	20	20
	PLLs	2	2	4	4	4	4	4	4	4	4	4	4
I/O Pins, and Architectural Features	I/O voltage levels supported (V)	1.2, 1.5, 1.8, 2.5, 3.3											
	I/O standards supported	LVTTTL, LVCMOS, PCI, PCI-X, LVDS, LVPECL, SSTL-18 (I and II), SSTL-2 (I and II), HSTL-18 (I and II), HSTL-15 (I and II), Differential SSTL-18 (I and II), Differential SSTL-2 (I and II), Differential HSTL											
	Emulated LVDS channels, 840 Mbps	66	66	136	79	223	159	177	229	-	-	-	-
	LVDS channels, 840 Mbps (receive/transmit)	-	-	-	-	-	-	-	-	169	169	169	169
	Memory devices supported	DDR2, DDR, SDR											

Package Options and I/O Pins: General-Purpose I/O (GPIO) Count, High-Voltage I/O Count, LVDS Pairs, and Transceiver Count

E144 pin (22 mm, 0.5 mm pitch)	94	94	84	82	-	-	-	-	-	-	-	-	-
M164 pin (8 mm, 0.5 mm pitch)	106	106	92	-	-	-	-	-	-	-	-	-	-
Q240 pin <sup>2</sup> (34.6 mm, 0.5 mm pitch)	-	-	160	148	128	-	-	-	-	-	-	-	-
U256 pin (14 mm, 0.8 mm pitch)	182	182	168	156	-	-	-	-	-	-	-	-	-
U484 pin (19 mm, 0.8 mm pitch)	-	-	346	-	331	327	295	-	294	294	-	-	-
F256 pin (17 mm, 1.0 mm pitch)	182	182	168	156	-	-	-	-	-	-	-	-	-
F324 pin (19 mm, 1.0 mm pitch)	-	-	-	215	196	-	-	-	-	-	-	-	-
F484 pin (23 mm, 1.0 mm pitch)	-	-	346	-	331	327	295	283	294	294	226	226	226
F780 pin (29 mm, 1.0 mm pitch)	-	-	-	-	535	377	429	531	429	429	429	429	429

Notes:  
 1. All data is correct at the time of printing, and may be subject to change without prior notice. For the latest information, please visit [www.altera.com](http://www.altera.com).  
 2. Plastic quad flat pack (PQFP).

94 Number indicates available user I/O pins.  
 Pin migration (same Vcc, GND, ISP, and input pins). User I/Os may be less than labelled for pin migration.

# MAX V AND MAX II CPLD FEATURES

View device ordering codes on [page 42](#).

PRODUCT LINE		MAX V CPLDS <sup>1</sup>						MAX II CPLDS <sup>1</sup>						
		5M40Z	5M80Z	5M160Z	5M240Z	5M570Z	5M1270Z	5M2210Z	EPM240Z	EPM570Z	EPM240	EPM570	EPM1270	EPM2210
Resources	LEs	40	80	160	240	570	1,270	2,210	-	-	-	-	-	-
	Equivalent macrocells <sup>2</sup>	32	64	128	192	440	980	1,700	192	440	192	440	980	1,700
	Pin-to-pin delay (ns)	7.5	7.5	7.5	7.5	9.0	6.2	7.0	4.7	5.4	7.5	9.0	6.2	7.0
	User flash memory (Kb)	8	8	8	8	8	8	8	8	8	8	8	8	8
	Logic convertible to memory <sup>3</sup>	Yes	Yes	Yes	Yes	Yes	Yes	Yes	Yes	-	-	-	-	-
Clocks, Maximum I/O Pins, and Architectural Features	Internal oscillator	✓	✓	✓	✓	✓	✓	✓	-	-	-	-	-	-
	Digital PLLs <sup>4</sup>	✓	✓	✓	✓	✓	✓	✓	-	-	-	-	-	-
	Fast power-on reset	✓	✓	✓	✓	✓	✓	✓	-	-	-	-	-	-
	Boundary-scan JTAG	✓	✓	✓	✓	✓	✓	✓	✓	✓	✓	✓	✓	✓
	JTAG ISP	✓	✓	✓	✓	✓	✓	✓	✓	✓	✓	✓	✓	✓
	Fast input registers	✓	✓	✓	✓	✓	✓	✓	✓	✓	✓	✓	✓	✓
	Programmable register power-up	✓	✓	✓	✓	✓	✓	✓	✓	✓	✓	✓	✓	✓
	JTAG translator	✓	✓	✓	✓	✓	✓	✓	✓	✓	✓	✓	✓	✓
	Real-time ISP	✓	✓	✓	✓	✓	✓	✓	✓	✓	✓	✓	✓	✓
	MultiVolt I/Os (V)	1.2, 1.5, 1.8, 2.5, 3.3						1.2, 1.5, 1.8, 2.5, 3.3, 5.0 <sup>5</sup>		1.5, 1.8, 2.5, 3.3			1.5, 1.8, 2.5, 3.3, 5.0 <sup>5</sup>	
	I/O power banks	2	2	2	2	2	4	4	2	2	2	2	4	4
	Maximum output enables	54	54	79	114	159	271	271	80	160	80	160	212	272
	LVTTTL/LVCMOS	✓	✓	✓	✓	✓	✓	✓	✓	✓	✓	✓	✓	✓
	LVDS outputs	✓	✓	✓	✓	✓	✓	✓	-	-	-	-	-	-
	32 bit, 66 MHz PCI compliant	-	-	-	-	-	✓ <sup>5</sup>	✓ <sup>5</sup>	-	-	-	-	✓ <sup>5</sup>	✓ <sup>5</sup>
Schmitt triggers	✓	✓	✓	✓	✓	✓	✓	✓	✓	✓	✓	✓	✓	
Programmable slew rate	✓	✓	✓	✓	✓	✓	✓	✓	✓	✓	✓	✓	✓	
Programmable pull-up resistors	✓	✓	✓	✓	✓	✓	✓	✓	✓	✓	✓	✓	✓	
Programmable GND pins	✓	✓	✓	✓	✓	✓	✓	✓	✓	✓	✓	✓	✓	
Open-drain outputs	✓	✓	✓	✓	✓	✓	✓	✓	✓	✓	✓	✓	✓	
Bus hold	✓	✓	✓	✓	✓	✓	✓	✓	✓	✓	✓	✓	✓	

Package Options and I/O Pins<sup>6</sup>

E64 pin (7 mm, 0.4 mm pitch)	54	54	54	-	-	-	-	-	-	-	-	-	-
T100 pin <sup>7</sup> (14 mm, 0.5 mm pitch)	-	79	79	79	74	-	-	-	-	80	76	-	-
T144 pin <sup>7</sup> (20 mm, 0.5 mm pitch)	-	-	-	114	114	114	-	-	-	-	116	116	-
M64 pin (4.5 mm, 0.5 mm pitch)	30	30	-	-	-	-	-	-	-	-	-	-	-
M68 pin (5 mm, 0.5 mm pitch)	-	52	52	52	-	-	-	54	-	-	-	-	-
M100 pin (6 mm, 0.5 mm pitch)	-	-	79	79	74	-	-	80	76	80	76	-	-
M144 pin (7 mm, 0.5 mm pitch)	-	-	-	-	-	-	-	-	116	-	-	-	-
M256 pin (11 mm, 0.5 mm pitch)	-	-	-	-	-	-	-	-	160	-	160	212	-
U256 pin (14 mm, 0.8 mm pitch)	-	-	-	-	-	-	-	-	-	-	-	-	-
F100 pin (11 mm, 1.0 mm pitch)	-	-	-	-	-	-	-	-	-	80	76	-	-
F256 pin (17 mm, 1.0 mm pitch)	-	-	-	-	159	211	204	-	-	-	160	212	204
F324 pin (19 mm, 1.0 mm pitch)	-	-	-	-	-	271	271	-	-	-	-	-	272

Notes:

- All data is correct at the time of printing, and may be subject to change without prior notice. For the latest information, please visit [www.altera.com](http://www.altera.com).
- Typical equivalent macrocells.
- Unused LEs can be converted to memory. The total number of available LE RAM bits depends on the memory mode, depth, and width configurations of the instantiated memory.
- Optional IP core.
- An external resistor must be used for 5.0 V tolerance.
- For temperature grades of specific packages (commercial, industrial, or extended temperatures), refer to Intel's online selector guide.
- Thin quad flat pack (TQFP).

54 Number indicates available user I/O pins.  
 Pin migration (same Vcc, GND, ISP, and input pins). User I/Os may be less than labelled for pin migration.



# CONFIGURATION DEVICES

View device ordering codes on [page 43](#).

[www.altera.com/products/configuration-devices/overview.html](http://www.altera.com/products/configuration-devices/overview.html)

The following information is an overview of our configuration devices. To determine the right configuration device for your FPGA, refer to the device datasheets and pin-out files available on the [Documentation: Configuration Devices](#) page.

Intel FPGA serial configuration devices store the configuration file for our SRAM-based FPGAs. We designed our serial configuration devices to minimize board space while providing a dedicated FPGA configuration solution. Serial configuration devices are recommended for new designs. For information on additional configuration devices supporting older products, refer to the device datasheets and pin-out files, available on the [Documentation: Configuration Devices](#) page.

## EPCQ-L SERIAL CONFIGURATION DEVICES FOR ARRIA 10 FPGAs (1.8 V)

FBGA	
24 pin 6 x 8 (mm) 1.0-mm pitch	
EPCQL256	256
EPCQL512	512
EPCQL1024	1,024

Notes:

512 Number indicates memory size in megabits (Mb).

Vertical migration (same  $V_{cc}$ , GND, ISP, and input pins).

## EPCQ SERIAL CONFIGURATION DEVICES FOR 28 NM AND PRIOR FPGAs (3.0–3.3 V)

SOIC		
	8 pin 4.9 x 6.0 (mm)	16 pin 10.3 x 10.3 (mm)
EPCQ16	16	
EPCQ32	32	
EPCQ64		64
EPCQ128		128
EPCQ256		256
EPCQ512		512

Notes:

512 Number indicates memory size in megabits (Mb).

Vertical migration (same  $V_{cc}$ , GND, ISP, and input pins).

# ORDERING CODES

## Ordering Information for Stratix 10 (GX/SX) Devices

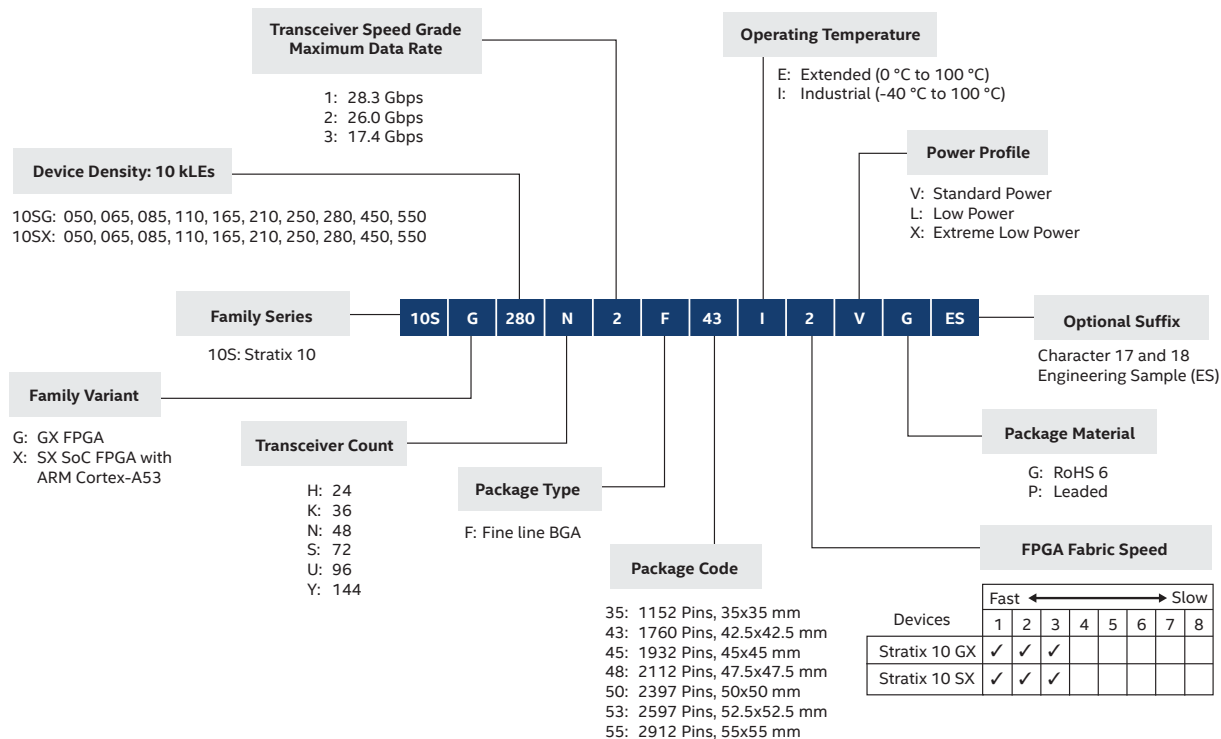

## Ordering Information for Arria 10 (GX, SX, GT) Devices

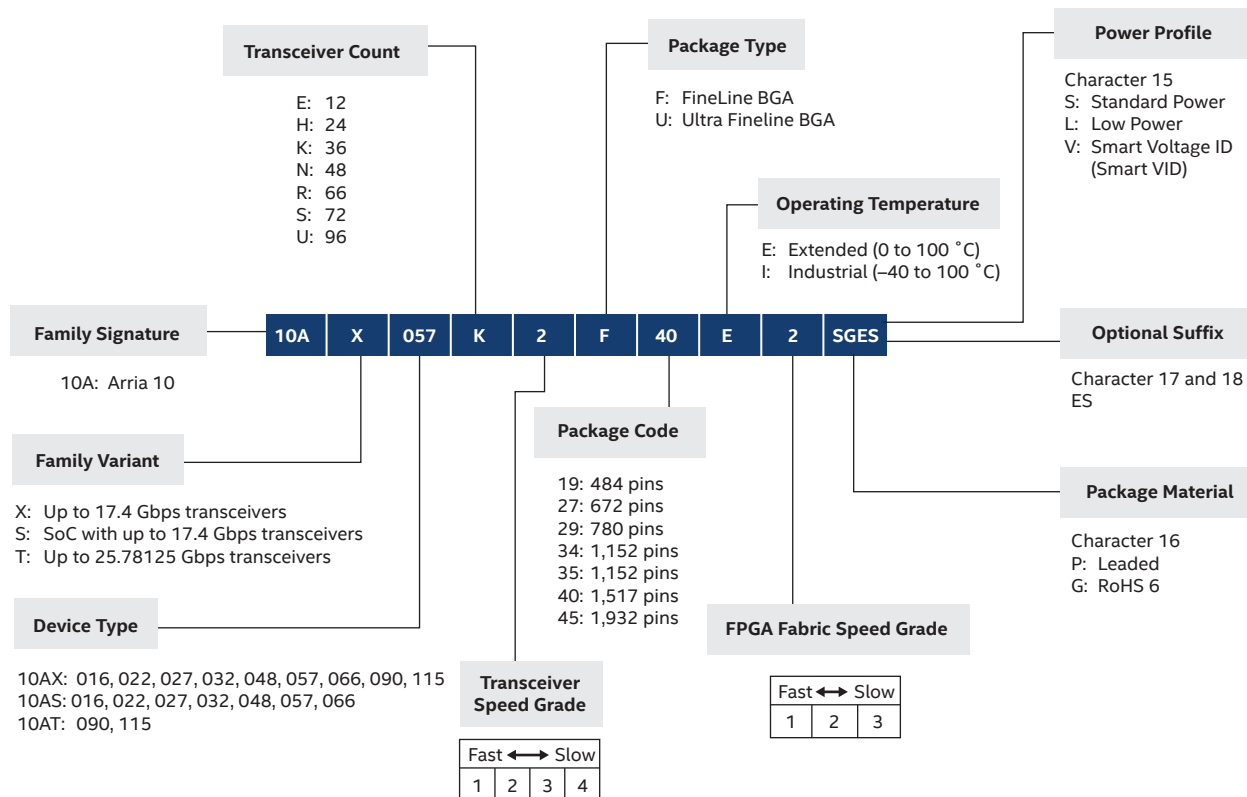

### Ordering Information for MAX 10 Devices

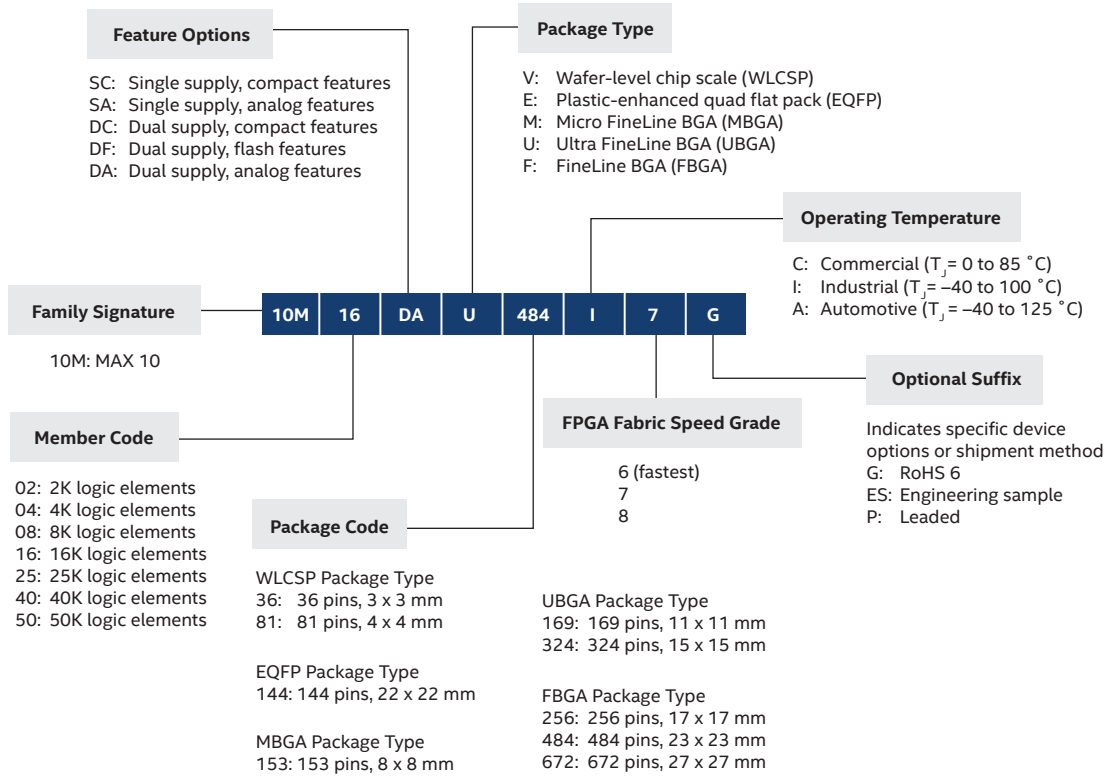

### Ordering Information for Stratix V (GT, GX, GS, E) Devices

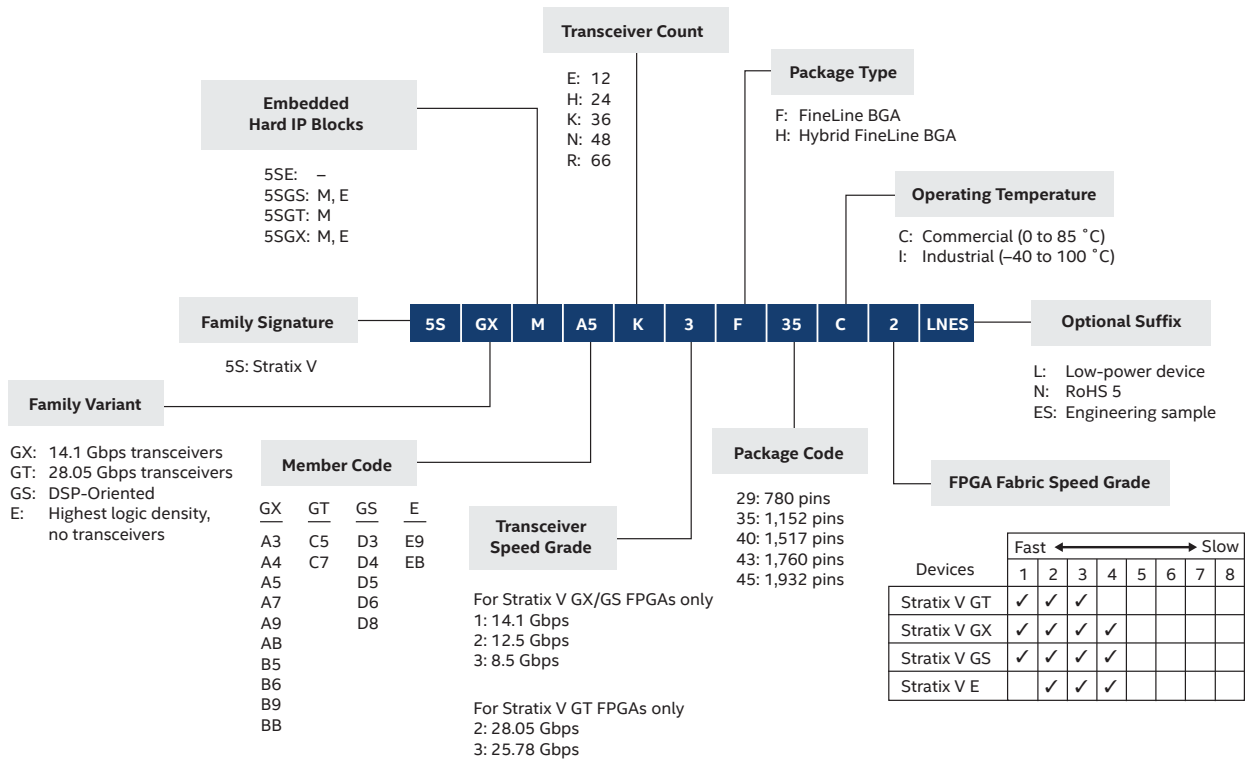

### Ordering Information for Arria V (GT, GX, GZ) Devices

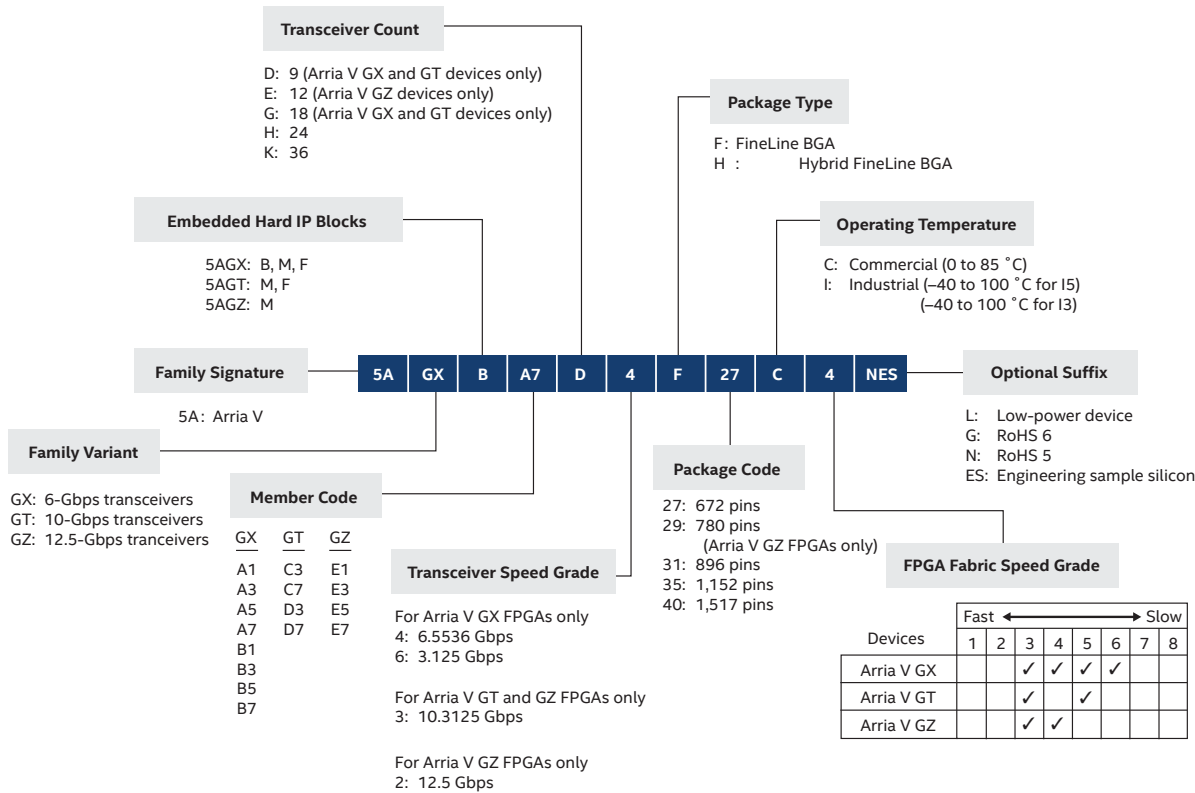

### Ordering Information for Arria V (SX, ST) SoCs

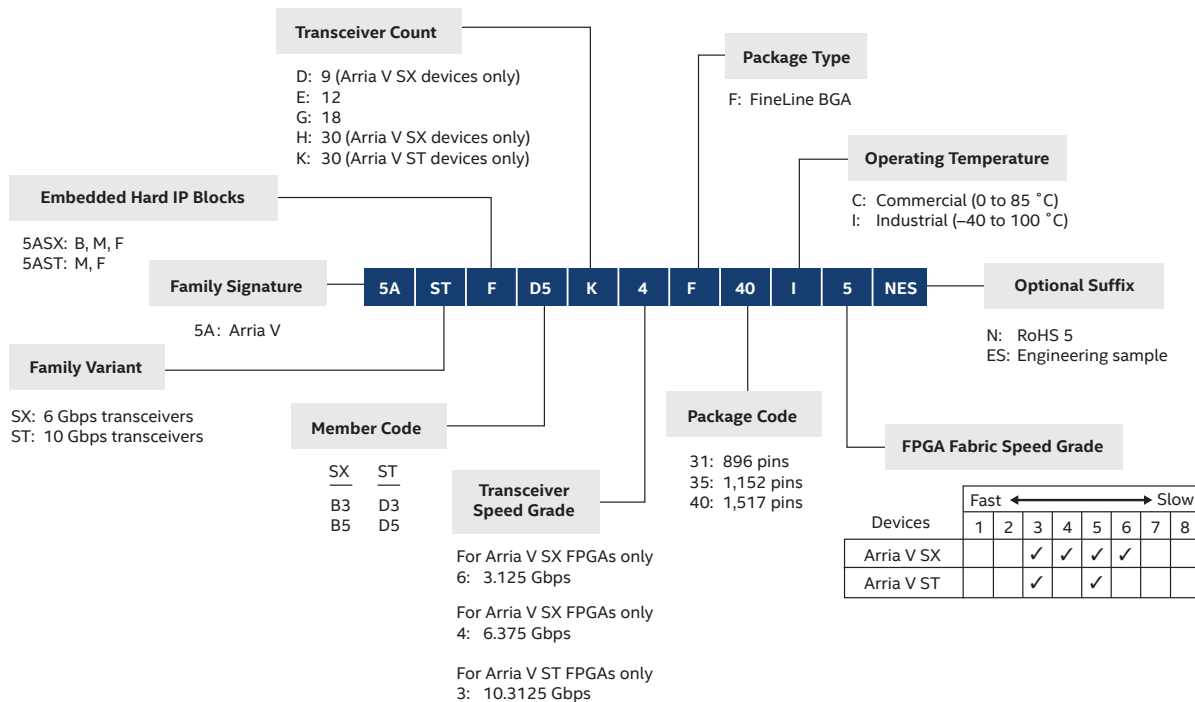

### Ordering Information for Cyclone V (E, GX, GT) Devices

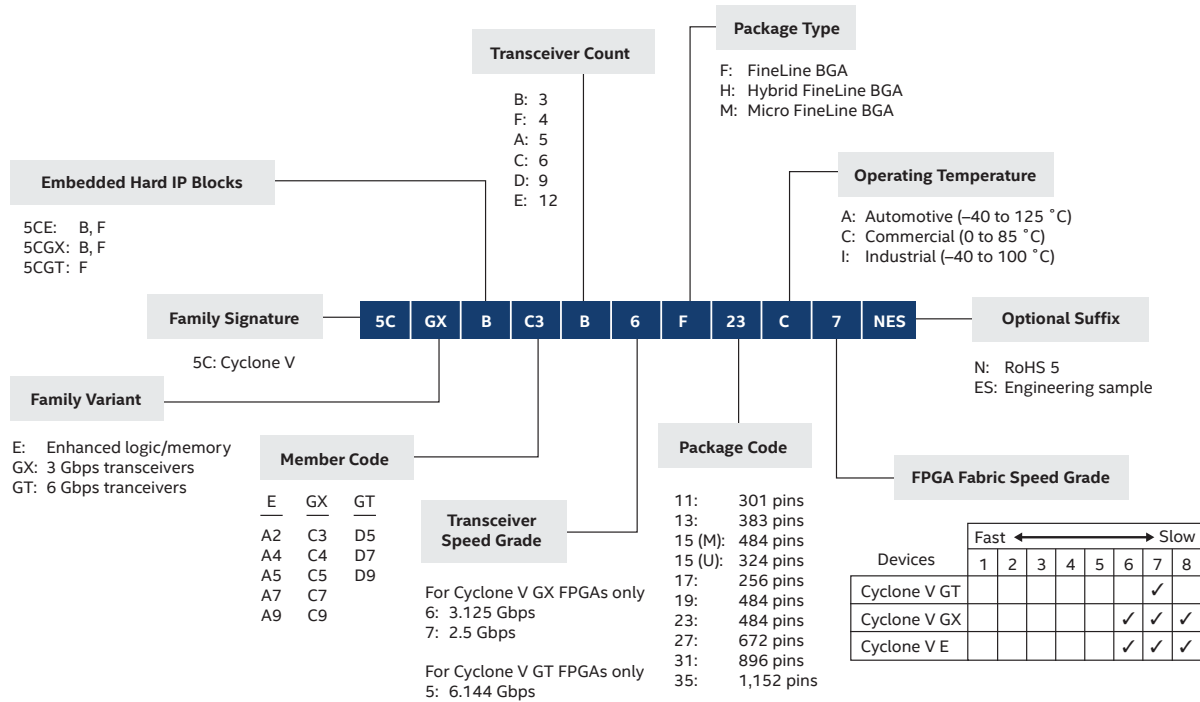

### Ordering Information for Cyclone V (SE, SX, ST) SoCs

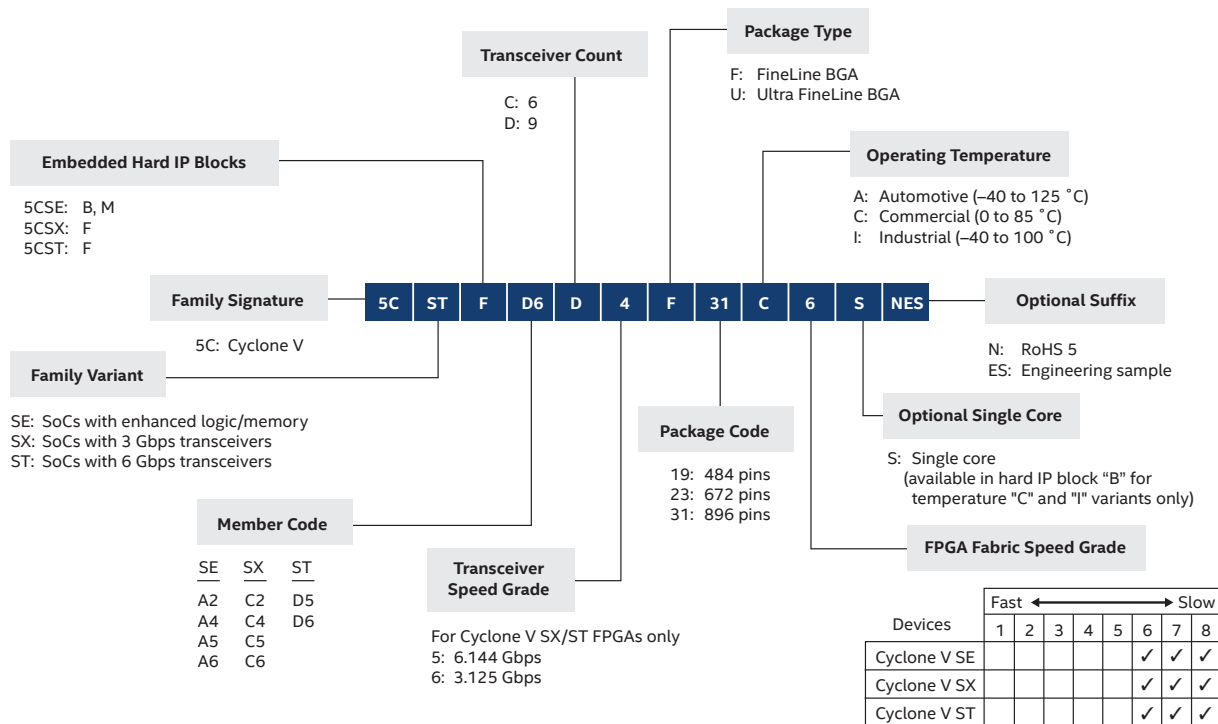

## Ordering Information for Stratix IV (E, GX, GT), Cyclone IV (E, GX), Cyclone III, Arria II GZ, Arria II GX, MAX V, and MAX II Devices

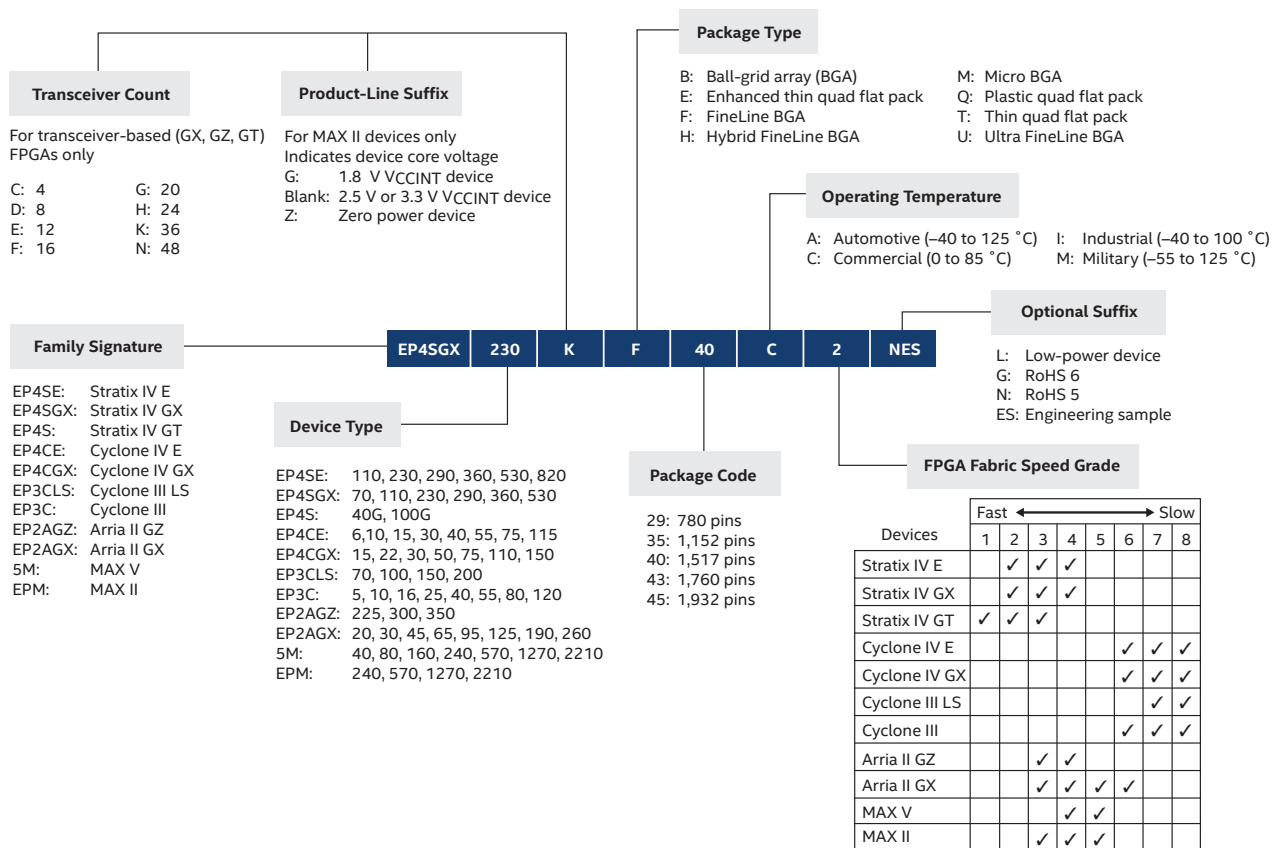

### Ordering Information for Serial Configuration Devices

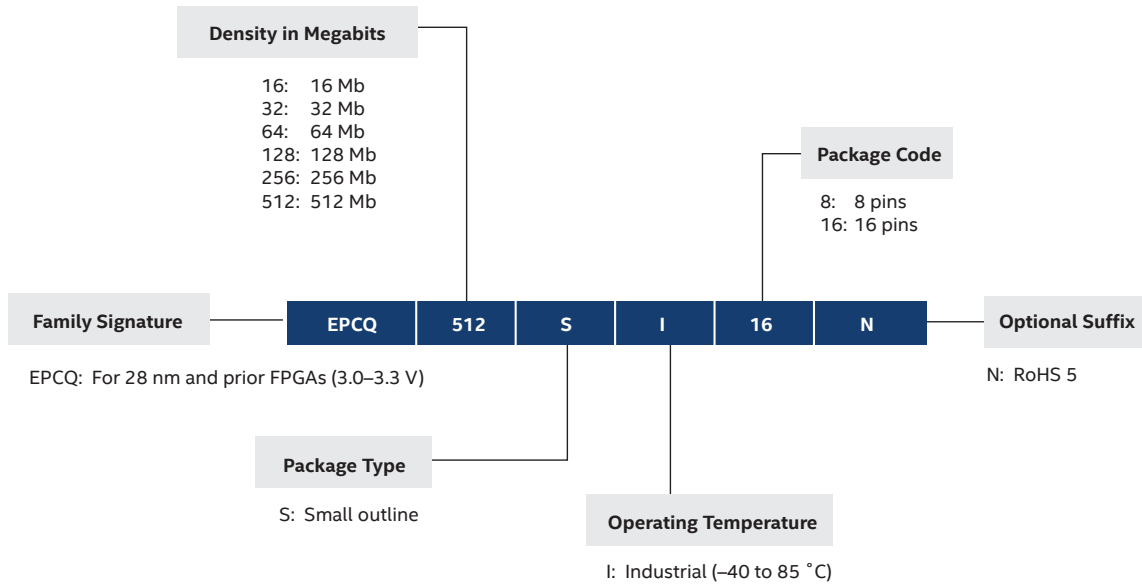
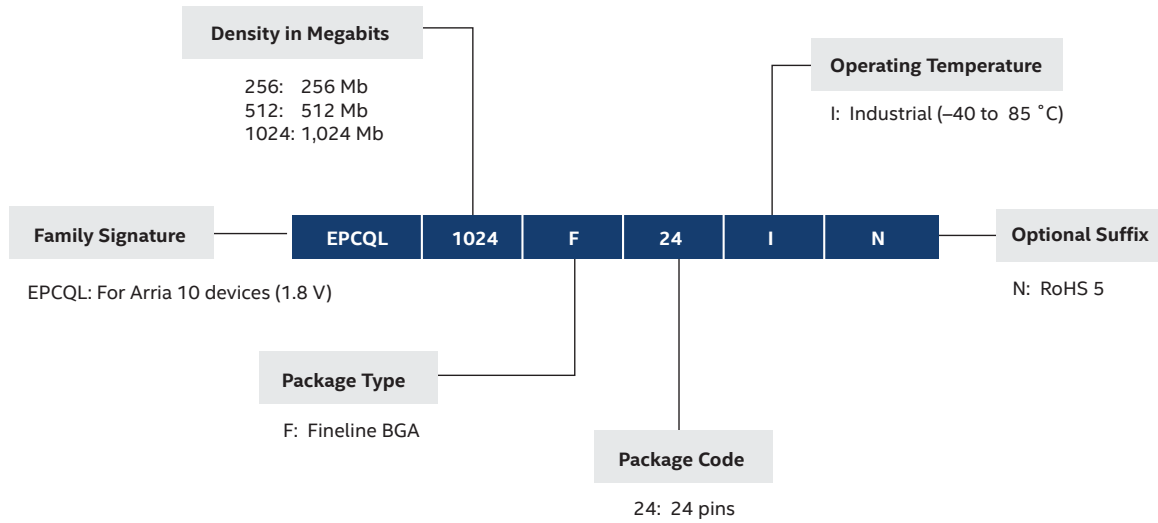

# ENPIRION POWER SOLUTIONS

[www.altera.com/enpirion](http://www.altera.com/enpirion)



Intel develops FPGAs and CPLDs using advanced process technologies that provide fast performance and high logic density.

To meet demanding power requirements, Intel's Enpirion Power Solutions products deliver the industry's first family of power system-on-chip (PowerSoC) DC-DC converters featuring integrated inductors. They provide an industry-leading combination of high efficiency, small footprint, and low-noise performance.



## Powering Your Innovation with Enpirion PowerSoCs

### Key Intellectual Property

- High-frequency power conversion
- Innovative magnetics engineering
- Advanced power packaging and construction

### Integrated Power Management Systems

- Industry leading integrated PowerSoC DC-DC step-down converters

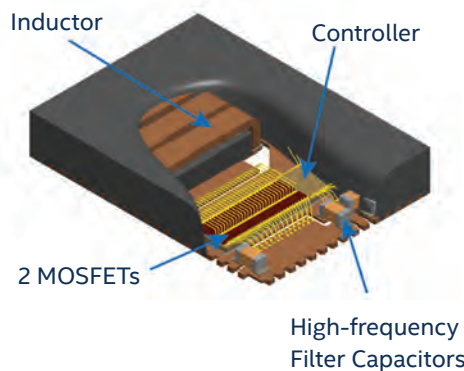

### Meeting Your Toughest Power Challenges

- Maximize performance
- Reduce system power consumption
- Increase power density
- Increase system reliability
- Accelerate time to revenue



# ENPIRION POWERSoC SOLUTIONS

Achieve Unprecedented Power Density and Performance with Enpirion PowerSoC DC-DC Step-Down Converters

Enpirion PowerSoC solutions integrate all the key elements of a DC-DC step-down converter in one easy-to-use package that provides:

**High Power Density and Small Footprint**

Greatly reduce the amount of PCB space required for your power supply while achieving up to 56 W/cm<sup>2</sup>.

**High Efficiency and Thermal Performance**

Optimized with up to 96 percent efficiency with industrial-grade and automotive-grade options available.

**Lowest Component Count and Higher Reliability**

Designed and manufacturing-tested as a complete power system to deliver 4 times longer mean time between failures (MTBF) reliability versus discrete solutions.

**Ease of Design and Fastest Time to Market**

Fully validated, turnkey designs that require over 40 percent less design time than discrete power solutions.

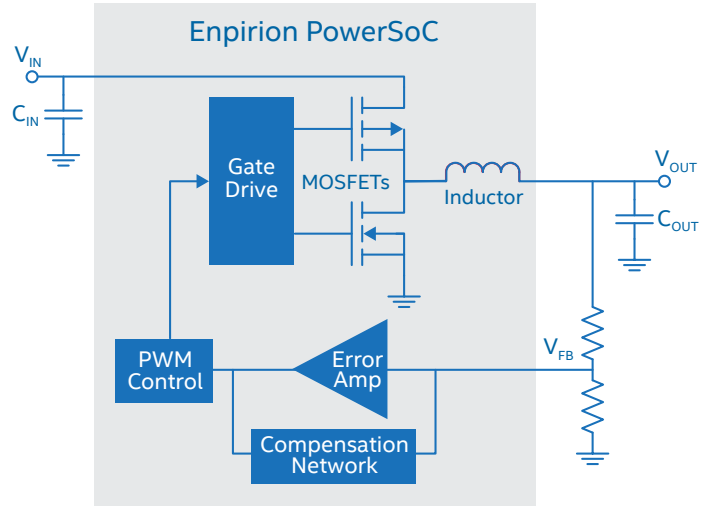

**Enpirion Offers Lower Ripple than the Competition**

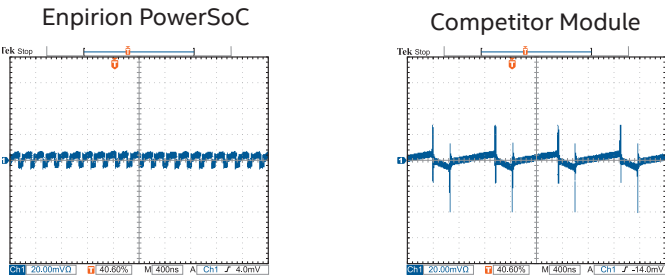

5 V Input, 3.3 V Output, 500 MHz Bandwidth

**Fast Transient Response Cuts Bulk Capacitance**

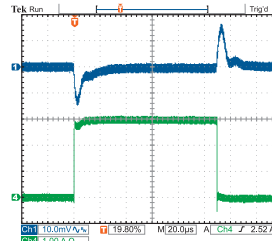

5 V Input, 3.3 V Output, <16 mV Deviation

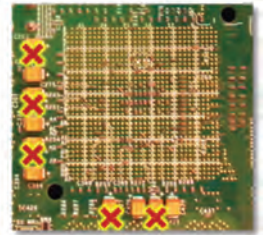

**Achieve Excellent EMI Performance**

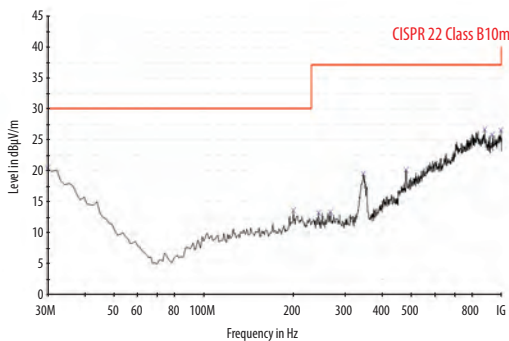

**Enpirion Delivers Significant Size and Cost Savings**

**Enpirion PowerSoC**



Only requires small 0805 capacitors

**Competitor Module**

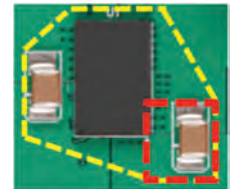

Requires components on both sides of the PCB, including larger 1210 capacitors

**FEATURED POWERSoC PRODUCTS**

PART NUMBER	MAX I <sub>OUT</sub> (A)	V <sub>IN</sub> RANGE (V)	V <sub>OUT</sub> RANGE (V)	SWITCHING FREQUENCY (MHZ)	PKG (PINS)	PKG SIZE (MM)			SOLUTION SIZE (MM) <sup>(1)</sup>	V <sub>OUT</sub> SET: VOLTAGE ID (VID)	POWER GOOD / POK FLAG	PROGRAMMABLE SOFT-START	PRECISION ENABLE	INPUT SYNCHRONIZATION	OUTPUT SYNCHRONIZATION	PARALLEL CAPABILITY	PROGRAMMABLE FREQUENCY	LIGHT LOAD MODE	AUTOMOTIVE-GRADE VERSION AVAILABLE
						L	W	H											
<b>FOOTPRINT-OPTIMIZED POWERSoCs</b>																			
EP5348UI	0.4	2.5 – 5.5	0.6 – V <sub>IN</sub> <sup>(2)</sup>	9.0	uQFN14	2.0	1.75	0.9	21										
EP5357/8HUI <sup>(3)</sup>	0.6	2.4 – 5.5	1.8 – 3.3	5.0	QFN16	2.5	2.25	1.1	14	*								*	*
EP5357/8LUJ <sup>(3)</sup>	0.6	2.4 – 5.5	0.6 – V <sub>IN</sub> <sup>(2)</sup>	5.0	QFN16	2.5	2.25	1.1	14	*								*	*
EP5368QI	0.6	2.4 – 5.5	0.6 – V <sub>IN</sub> <sup>(2)</sup>	4.0	QFN16	3.0	3.0	1.1	21	*									
EP5388QI	0.8	2.4 – 5.5	0.6 – V <sub>IN</sub> <sup>(2)</sup>	4.0	QFN16	3.0	3.0	1.1	28	*									
EP53A7/8HQI <sup>(3)</sup>	1.0	2.4 – 5.5	1.8 – 3.3	5.0	QFN16	3.0	3.0	1.1	21	*								*	*
EP53A7/8LQI <sup>(3)</sup>	1.0	2.4 – 5.5	0.6 – V <sub>IN</sub> <sup>(2)</sup>	5.0	QFN16	3.0	3.0	1.1	21	*								*	*
EN5311QI	1.0	2.4 – 6.6	0.6 – V <sub>IN</sub> <sup>(2)</sup>	4.0	QFN20	4.0	5.0	1.1	36	*									
EP53F8QI	1.5	2.4 – 5.5	0.6 – V <sub>IN</sub> <sup>(2)</sup>	4.0	QFN16	3.0	3.0	1.1	40		*								
EN5319QI	1.5	2.4 – 5.5	0.6 – V <sub>IN</sub> <sup>(2)</sup>	3.2	QFN24	4.0	6.0	1.1	50		*								
EN5322QI	2.0	2.4 – 5.5	0.6 – V <sub>IN</sub> <sup>(2)</sup>	4.0	QFN24	4.0	6.0	1.1	58	*	*								
EN5329QI	2.0	2.4 – 5.5	0.6 – V <sub>IN</sub> <sup>(2)</sup>	3.2	QFN24	4.0	6.0	1.1	50		*								
EN5337QI	3.0	2.4 – 5.5	0.75 – V <sub>IN</sub> <sup>(2)</sup>	5.0	QFN38	4.0	7.0	1.85	75	*	*	*	*					*	*
EN5339QI	3.0	2.4 – 5.5	0.6 – V <sub>IN</sub> <sup>(2)</sup>	3.2	QFN24	4.0	6.0	1.1	55		*								
EN5365/6QI <sup>(4)</sup>	6.0	2.4 – 5.5	0.75 – 3.3/V <sub>IN</sub> <sup>(2)</sup>	5.0	QFN58	10.0	12.0	1.85	229	*	*	*	*					*	*
EN5367QI	6.0	2.5 – 5.5	0.75 – V <sub>IN</sub> <sup>(2)</sup>	4.0	QFN54	5.5	10.0	3.0	160		*	*	*	*				*	*
EN5395/6QI <sup>(4)</sup>	9.0	2.4 – 5.5	0.75 – 3.3/V <sub>IN</sub> <sup>(2)</sup>	5.0	QFN58	10.0	12.0	1.85	277	*	*	*	*					*	*
<b>PERFORMANCE-OPTIMIZED AND WIDE V<sub>IN</sub> POWERSoCs</b>																			
EN6310QI	1.0	2.7 – 5.5	0.6 – 3.3	2.2	QFN30	4.0	5.0	1.85	65		*	*							*
EN5335/6QI <sup>(4)</sup>	3.0	2.4 – 6.6	0.75 – 3.3/V <sub>IN</sub> <sup>(2)</sup>	5.0	QFN44	7.5	10.0	1.85	157	*	*	*							
EN6337QI	3.0	2.5 – 6.6	0.75 – V <sub>IN</sub> <sup>(2)</sup>	1.9	QFN38	4.0	7.0	1.85	75		*	*	*	*				*	*
EN6347QI	4.0	2.5 – 6.6	0.75 – V <sub>IN</sub> <sup>(2)</sup>	3.0	QFN38	4.0	7.0	1.85	75		*	*	*	*				*	*
EN2342QI	4.0	4.5 – 14.0	0.75 – 5.0	0.9 – 1.8	QFN68	8.0	11.0	3.0	200		*	*	*	*	*	*	*	*	*
EN5364QI	6.0	2.4 – 6.6	0.6 – V <sub>IN</sub> <sup>(2)</sup>	4.0	QFN68	8.0	11.0	1.85	160		*	*	*	*	*	*	*	*	*
EN6362QI	6.0	3.0 – 6.5	0.6 – V <sub>IN</sub> <sup>(2)</sup>	0.9 – 1.5	QFN56	8.0	8.0	3.0	170		*	*	*	*	*	*	*	*	*
EN6360QI	8.0	2.5 – 6.6	0.6 – V <sub>IN</sub> <sup>(2)</sup>	0.9 – 1.5	QFN68	8.0	11.0	3.0	190		*	*	*	*	*	*	*	*	*
EN5394QI	9.0	2.4 – 6.6	0.6 – V <sub>IN</sub> <sup>(2)</sup>	4.0	QFN68	8.0	11.0	1.85	190		*	*	*	*	*	*	*	*	*
EN63AOQI	12.0	2.5 – 6.6	0.6 – V <sub>IN</sub> <sup>(2)</sup>	0.9 – 1.5	QFN76	10.0	11.0	3.0	225		*	*	*	*	*	*	*	*	*
<b>LOW DROPOUT REGULATORS (LDOS)</b>																			
EY1602SI-ADJ	0.05	6.0 – 40.0	2.5 – 12.0		SOIC8	6.2	5.0	1.68	~45										
EY1603TI-ADJ	0.15	6.0 – 40.0	2.5 – 12.0		TSSOP14	6.4	5.0	0.9	~45										
EY1501DI-ADJ	1.0	2.2 – 6.0	0.8 – 5.0		DFN10	3.0	3.0	1.0	~15		*	*							
<b>DC-DC Regulators</b>																			
ER3105QI	0.5	3.0 – 36.0	0.6 – 34.0	0.3 – 2.0	DFN12	4.0	3.0	1.0	~160		*	*	*	*	*	*	*	*	*
ER3110QI	1.0	3.0 – 36.0	0.6 – 12.0	0.3 – 2.0	DFN12	4.0	3.0	1.0	~160		*	*	*	*	*	*	*	*	*
ER2120QI	2.0	5.0 – 14.0	0.6 – 5.0	0.5 – 1.2	QFN24	4.0	4.0	0.9	~165		*	*	*	*	*	*	*	*	*
ER3125QI <sup>(6)</sup>	2.5	3.0 – 36.0	0.8 – 36.0	0.2 – 2.2	DFN20	4.0	4.0	0.9	~225		*	*	*	*	*	*	*	*	*
<b>HIGH EFFICIENCY DDR MEMORY TERMINATION (VTT)</b>																			
EV1320QI	2.0	0.95 – 1.8	0.5 – 0.9	0.625	QFN16	3.3	3.3	0.9	40		*	*				*	*	*	*
EV1340QI	5.0	1.0 – 1.8	0.6 – 0.9	1.5	QFN54	5.5	10.0	3.0	125		*	*				*	*	*	*
EV1380QI	8.0	1.2 – 1.65	0.6 – 0.825	1.25 – 1.75	QFN68	8.0	11.0	3.0	200		*	*	*	*	*	*	*	*	*

For a complete list of Enpirion power products, please visit [www.altera.com/enpirion-power-solutions.html](http://www.altera.com/enpirion-power-solutions.html).

Notes:

1. Size estimate for single-sided PCB including all suggested external components. Smaller size may be possible with double-sided PCB design.
2. Maximum V<sub>OUT</sub> = V<sub>IN</sub> – V<sub>DROPOUT</sub>, where V<sub>DROPOUT</sub> = R<sub>DROPOUT</sub> × Load Current. Reference device datasheet to calculate V<sub>DROPOUT</sub>.
3. Only "7" version features Light Load Mode. Only "8" version available in Automotive-Grade.
4. Only "5" version features V<sub>OUT</sub> Set by VID.
5. Supports both buck and buck-boost modes of operation.

Also available:

- ES1030QI: Tiny, Low Profile, Four-channel Power Rail Sequencer
- EC7401QI: Multi-phase Controller with Voltage ID (VID) Compliant Interface
- ED8101P0xQI: Single-Phase Digital Controller with PMBus Compliant Interface
- ED8106N0xQI: Single-Phase Digital Controller
- EC7100VQI: Single-phase PWM Controller

# INTEL QUARTUS PRIME DESIGN SOFTWARE

[www.altera.com/products/software](http://www.altera.com/products/software)

The Intel Quartus Prime software is number one in performance and productivity for FPGA, CPLD, and SoC designs, providing the fastest path to convert your concept into reality. The Quartus Prime software also supports many third-party tools for synthesis, static timing analysis, board-level simulation, signal integrity analysis, and formal verification.

## QUARTUS PRIME SOFTWARE DESIGN FLOW

		AVAILABILITY		
		LITE EDITION (FREE)	STANDARD EDITION (\$)	PRO EDITION (\$)
Device Support	QUARTUS PRIME SOFTWARE KEY FEATURES			
	Cyclone, MAX, and Arria II device support	✓ <sup>1</sup>	✓	
	Arria and Stratix device support		✓	
	Arria 10 device support		✓	✓
	Multiprocessor support (faster compile time)		✓	✓
Design Entry	IP Base Suite	Available for purchase	✓	✓
	Qsys	✓	✓	✓
	Qsys Pro			✓
	Rapid Recompile		✓ <sup>2</sup>	✓
	BluePrint Platform Designer			3
Functional Simulation	ModelSim*-Intel FPGA Starter Edition software	✓	✓	✓
	ModelSim-Intel FPGA Edition software	✓ <sup>3</sup>	✓ <sup>3</sup>	✓ <sup>3</sup>
Synthesis	Industry-standard language for design portability			✓
Placement and Routing	Fitter (Place and Route)	✓	✓	
	Incremental Optimization			✓
	Hybrid Placer		✓ <sup>4</sup>	✓
Design Flow	Partial Reconfiguration			✓
Timing and Power Verification	TimeQuest Static Timing Analyzer	✓	✓	✓
	PowerPlay Power Analyzer	✓	✓	✓
In-System Debug	SignalTap™ II Logic Analyzer	✓ <sup>5</sup>	✓	✓
	Transceiver toolkit		✓	✓
	JNEye link analysis tool		✓	✓
Operating System (OS) Support	Windows*/Linux* 64 bit support	✓	✓	✓
Add-On Development Tools	Intel FPGA SDK for OpenCL	✓ <sup>3</sup>	✓ <sup>3</sup>	✓ <sup>3</sup>
	DSP Builder for Intel FPGAs	✓ <sup>3</sup>	✓ <sup>3</sup>	✓ <sup>3</sup>
	Nios II Embedded Design Suite	✓	✓	✓
	Intel SoC FPGA Embedded Design Suite	✓	✓	✓

### Notes:

1. The only Arria II FPGA supported is the EP2AGX45 device.
2. Available for Stratix V, Arria V, and Cyclone V devices.
3. Requires an additional license.
4. Available for Arria 10, Stratix V, Arria V, and Cyclone V devices.

## QUARTUS PRIME DESIGN SOFTWARE FEATURES SUMMARY

DESIGN FLOW METHODOLOGY	BluePrint Platform Designer	Platform designer tool that enables you to quickly create your I/O design using real time legality checks.
	Pin planner	Eases the process of assigning and managing pin assignments for high-density and high-pin-count designs.
	Qsys or Qsys Pro	Automates system development by integrating IP functions and subsystems (collection of IP functions) using a hierarchical approach and a high-performance interconnect based on a network-on-a-chip architecture.
	Off-the-shelf IP cores	Lets you construct your system-level design using IP cores from Intel and from Intel's third-party IP partners.
	Synthesis	Now with expanded language support for System Verilog and VHDL 2008.
	Scripting support	Supports command-line operation and Tcl scripting, as well as graphical user interface (GUI) design.
	Rapid Recompile	Maximizes your productivity by reducing your compilation time up to 4X (for a small design change after a full compile). Improves design timing preservation.
	Incremental Optimization	The incremental optimizations capability in the Quartus Prime Pro Edition software offers a faster methodology to converge to design sign-off. The traditional fitter stage is divided into finer stages for more control over the design flow.
	Partial Reconfiguration	Create a physical region on the FPGA that can be reconfigured to execute different functions. Synthesize, place, route, close timing, and generate configuration bit streams for the functions implemented in the region.
PERFORMANCE AND TIMING CLOSURE METHODOLOGY	Physical synthesis	Uses post placement and routing delay knowledge of a design to improve performance.
	Design space explorer (DSE)	Increases performance by automatically iterating through combinations of Quartus Prime software settings to find optimal results.
	Extensive cross-probing	Provides support for cross-probing between verification tools and design source files.
	Optimization advisors	Provides design-specific advice to improve performance, resource usage, and power consumption.
	Chip planner	Reduces verification time while maintaining timing closure by enabling small, post placement and routing design changes to be implemented in minutes.
VERIFICATION	TimeQuest timing analyzer	Provides native Synopsys* Design Constraint (SDC) support and allows you to create, manage, and analyze complex timing constraints and quickly perform advanced timing verification.
	SignalTap II logic analyzer <sup>1</sup>	Supports the most channels, fastest clock speeds, largest sample depths, and most advanced triggering capabilities available in an embedded logic analyzer.
	System Console	Enables you to easily debug your FPGA in real time using read and write transactions. It also enables you to quickly create a GUI to help monitor and send data into your FPGA.
	PowerPlay technology	Enables you to analyze and optimize both dynamic and static power consumption accurately.
THIRD-PARTY SUPPORT	EDA partners	Offers EDA software support for synthesis, functional and timing simulation, static timing analysis, board-level simulation, signal integrity analysis, and formal verification. To see a complete list of partners, visit <a href="http://www.altera.com/eda-partners">www.altera.com/eda-partners</a> .

## Notes:

1. Available with Talkback feature enabled in Quartus Prime Lite Edition software.

## Getting Started Steps

Step 1: Download the free Quartus Prime Lite Edition software

[www.altera.com/download](http://www.altera.com/download)

Step 2: Get oriented with the Quartus Prime software interactive tutorial

After installation, open the interactive tutorial on the welcome screen.

Step 3: Sign up for training

[www.altera.com/training](http://www.altera.com/training)

# QUARTUS PRIME DESIGN SOFTWARE

Purchase the Quartus Prime software and increase your productivity today.

QUARTUS PRIME SOFTWARE		STANDARD EDITION	PRO EDITION <sup>1</sup>	UPGRADE TO PRO EDITION <sup>2</sup>
Fixed	New	\$2,995	\$3,995	\$995
	Renewal	\$2,495	\$3,395	
Float / Float Add Seats	New	\$3,995	\$4,995	\$995
	Renewal	\$3,295	\$4,295	

Notes:  
 1. The Quartus II Subscription Edition software or Quartus Prime Standard Edition software is included when you purchase the Quartus Prime Pro Edition software.  
 2. Current customers with valid Quartus II Subscription Edition software or Quartus Prime Standard Edition software licenses are eligible to upgrade to Pro Edition. The number of upgrades available for purchase is equal to number of valid Standard or Subscription Edition software licenses.

MODELSIM-INTEL FPGA EDITION SOFTWARE	MODELSIM-INTEL FPGA STARTER EDITION SOFTWARE
\$1,995 Renewal \$1,695	Free
The ModelSim-Intel FPGA Edition software is available as a \$1,995 option for both the Quartus Prime Standard Edition and Lite Edition software. It is 33 percent faster than the Starter Edition software with no line limitation.	Free for both Quartus Prime Standard Edition and Lite Edition software with a 10,000 executable line limitation. The ModelSim-Intel FPGA Starter Edition software is recommended for simulating small FPGA designs.

# DSP BUILDER FOR INTEL FPGAs

[www.altera.com/dspbuilder](http://www.altera.com/dspbuilder)

DSP Builder for Intel FPGAs is a DSP development tool that allows push-button HDL generation of DSP algorithms directly from the MathWorks\* Simulink\* environment. The DSP Builder for Intel FPGAs allows you to design algorithm, set the desired data rate, clock frequency, and device, offering accurate bit and cycle simulation, synthesizing fixed- and floating-point optimized HDL, auto-verify in ModelSim-Intel FPGA software, and auto-verify or co-simulate on hardware. This tool adds additional libraries alongside existing Simulink libraries with the DSP Builder Advanced Blockset and DSP Builder Standard Blockset. Intel recommends using the DSP Builder Advanced Blockset for new designs. The DSP Builder Standard Blockset is not recommended for new designs except as a wrapper for the DSP Builder Advanced Blockset.

FEATURES	DSP BUILDER STANDARD BLOCKSET	DSP BUILDER ADVANCED BLOCKSET
High-level optimization		✓
Auto pipeline insertion		✓
Floating-point blocks		✓
Resource sharing		✓
IP-level blocks	✓	✓
Low-level blocks	✓	✓
System integration	✓	✓
Hardware co-simulation	✓	✓

## DSP BUILDER FOR INTEL FPGAs FEATURES SUMMARY

The DSP Builder Advanced Blockset offers the following features:

- Arithmetic logic unit (ALU) folding to build custom ALU processor architectures from a flat data-rate design
- High-level synthesis optimizations, auto-pipeline insertion and balancing, and targeted hardware mapping
- High-performance fixed- and floating-point DSP with vector processing
- Auto memory mapping
- Single system clock datapath
- Flexible 'white-box' fast Fourier transform (FFT) toolkit with an open hierarchy of libraries and blocks for users to build custom FFTs

Generate resource utilization tables for all designs without Quartus Prime software compile.

Automatically generate projects or scripts for the Quartus Prime software, the ModelSim-Intel FPGA software, TimeQuest, and Qsys.

Purchase DSP Builder for Intel FPGAs to meet high-performance DSP design needs today.

PRICING	OPERATING SYSTEM
\$1,995 Primary \$1,995 Renewal Subscription for one year	Windows/ Linux

# INTEL FPGA SDK FOR OPENCL

[www.altera.com/opencl](http://www.altera.com/opencl)

The Intel FPGA SDK for OpenCL<sup>1</sup> allows you to implement applications in FPGAs easily by abstracting away the complexities of FPGA design. Software programmers can write hardware-accelerated kernel functions in OpenCL C, an ANSI C-based language with additional OpenCL constructs to extract parallelism. Using the FPGA as an accelerator provides significant advantages over using a CPU or GPU: with an FPGA, you use customized small scalar or large vector processing units or a deep hardware pipeline to create a completely custom accelerator at the lowest possible power.

## INTEL FPGA SDK FOR OPENCL SOFTWARE FEATURES SUMMARY

Altera Offline Compiler (AOC)	<ul style="list-style-type: none"> <li>• GCC-based model compiler of OpenCL kernel code</li> </ul>
Altera OpenCL Utility (AOCL)	<ul style="list-style-type: none"> <li>• Diagnostics for board installation</li> <li>• Flash or program FPGA image</li> <li>• Install board drivers (typically PCIe)</li> </ul>
Intel FPGA SDK for OpenCL Licensing	<ul style="list-style-type: none"> <li>• Purchase a one-year perpetual license (\$995)<sup>2</sup></li> <li>• Purchase a one-year renewal license (\$895)</li> <li>• Fixed-node and floating-node licenses available</li> <li>• 60-day evaluation license available on request</li> </ul>
Operating System	<ul style="list-style-type: none"> <li>• Microsoft Windows 8.1</li> <li>• Microsoft 64 bit Windows 7</li> <li>• Red Hat Enterprise 64 bit Linux (RHEL) 6.x</li> </ul>
Memory Requirements	<ul style="list-style-type: none"> <li>• Computer equipped with at least 32 GB RAM</li> </ul>

OpenCL™ and the OpenCL logo are trademarks of Apple Inc. used by permission by Khronos.

### Notes:

1. Product is based on a published Khronos Specification, and has passed the Khronos Conformance Testing Process. Current conformance status can be found at [www.khronos.org/conformance](http://www.khronos.org/conformance).
2. The OpenCL license allows you to use the Quartus Prime software from the OpenCL software but with restricted functionality. The full Quartus Prime Standard Edition license is required to access the full functionality of the Quartus Prime software.

# INTEL SoC FPGA EMBEDDED DESIGN SUITE

[www.altera.com/soc-eds](http://www.altera.com/soc-eds)

The Intel SoC FPGA Embedded Design Suite (EDS) is a comprehensive tool suite for embedded software development on Intel SoC FPGAs. It comprises development tools, utility programs, and design examples to jump-start firmware and application software development. In addition, the Intel SoC FPGA EDS includes an exclusive offering of the ARM DS-5 AE. This toolkit enables embedded developers to code, build, debug, and optimize in a single Eclipse-based IDE. ARM DS-5 AE licenses are available in two options: a free limited license and a paid full-featured license that also includes 1-year support and maintenance. A full-featured ARM DS-5 AE license is included at no cost with Intel SoC FPGA Development Kits.

## INTEL SoC FPGA EMBEDDED DESIGN SUITE

		AVAILABILITY	
		LITE (FREE)	STANDARD (PAID)
DS-5 Intel Edition Features	Linux application debugging over Ethernet	✓	✓
	Debugging over USB-Blaster™ II cable <ul style="list-style-type: none"> <li>· Board bring-up</li> <li>· Device driver development</li> <li>· Operating system (OS) porting</li> <li>· Bare-metal programming</li> <li>· ARM CoreSight trace support</li> </ul>		✓
	Debugging over DSTREAM <ul style="list-style-type: none"> <li>· Board bring-up</li> <li>· Device driver development</li> <li>· OS porting</li> <li>· Bare-metal programming</li> <li>· ARM CoreSight trace support</li> </ul>		✓
	FPGA-adaptive debugging <ul style="list-style-type: none"> <li>· Auto peripheral register discovery</li> <li>· Cross-triggering between CPU and FPGA domains</li> <li>· ARM CoreSight trace support</li> <li>· Access to System Trace Module (STM) events</li> </ul>		✓
	Streamline Performance Analyzer support	Limited	✓
	Compiler Tools	Linaro Compiler	✓
	Sourcery CodeBench Lite ARM EABI GCC	✓	✓
	ARM Compiler 5 (included in the DS-5 AE)		✓
Libraries	Hardware Libraries (HWLIBs)	✓	✓
Other Tools	Quartus Prime Programmer	✓	✓
	SignalTap II Logic Analyzer	✓	✓
	Altera Boot Disk Utility	✓	✓
	Device Tree Generator	✓	✓
Design Examples	Golden system reference designs for SoC development kits	✓	✓
	Device-wide asymmetric multiprocessing <sup>1</sup>	✓	✓
	Triple Speed Ethernet (TSE) with Modular Scatter-Gather Direct Memory Access (mSG-DMA) <sup>1</sup>	✓	✓
	PCIe Root Port with Message Signal Interrupts (MSI) <sup>1</sup>	✓	✓
Host OS Support	Windows 7 64 bit	✓	✓
	Windows 7 32 bit	Not supported	Not supported
	Red Hat Linux 5/6 64 bit	32 bit libraries are required	32 bit libraries are required

Notes:

1. These design examples are only available through [RocketBoards.org](http://RocketBoards.org).



# NIOS II PROCESSOR EMBEDDED DESIGN SUITE

The Nios II processor, the world's most versatile processor according to Gartner Research, is the most widely used soft processor in the FPGA industry. This soft processor delivers unprecedented flexibility for your cost-sensitive, real-time, safety-critical (DO-254), and applications processing needs. All Intel FPGA families support the Nios II processor.

## NIOS II EDS CONTENTS

Nios II Software Build Tools for Eclipse (Nios II SBT for Eclipse), for software development

- Based on Eclipse IDE
- New project wizards
- Software templates
- Source navigator and editor

Compiler for C and C++ (GNU)

Software Debugger/Profiler

Flash Programmer

Embedded Software

- Hardware Abstraction Layer (HAL)
- MicroC/OS-II RTOS (full evaluation version)
- NicheStack TCP/IP Network Stack—Nios II Edition
- Newlib ANSI-C standard library
- Simple file system

Other Intel Command-Line Tools and Utilities

Design Examples

## Hardware Development Tools

- Quartus Prime design software
- Qsys system integration tool
- SignalTap II embedded logic analyzer plug-in for Nios II processor
- System Console for low-level debugging of Qsys systems

## Licensing

Getting started with the Nios II processor is now easier than ever. Not only is the Nios II EDS free, but the Nios II economy core IP is also free.

Licenses for the Nios II standard and fast core IP are available for stand-alone IP (IP-NIOS) or as part of the Embedded IP Suite (IPS-EMBEDDED). These royalty-free licenses never expire and allow you to target your processor design to any Intel FPGA. The Embedded IP Suite is a value bundle that contains licenses of the Nios II processor IP core, DDR1/2/3 Memory Controller IP cores, Triple-Speed Ethernet MAC IP core and 16550 - compatible UART IP core<sup>1</sup>. Both Nios II Classic and Gen2 processors are included in these licenses.

## Nios II EDS: What You Get for Free!

The Nios II Embedded Design Suite (EDS) provides all the tools and software you need to develop code for the Nios II processor and Nios II Gen2 processors.

With the Nios II EDS you can:

- **Develop software with Nios II SBT for Eclipse:**  
Based on industry-standard Eclipse, the Nios II SBT is an integrated development environment for editing, compiling, debugging software code, and flash programming.
- **Manage board support packages (BSPs):**  
The Nios II EDS makes managing your BSP easier than ever. Nios II EDS automatically adds device drivers for Intel FPGA-provided IP to your BSP. The BSP Editor provides full control over your build options.
- **Get a free software network stack:**  
The Nios II EDS includes NicheStack TCP/IP Network Stack - Nios II Edition—a commercial-grade network stack software—for free.
- **Evaluate a RTOS:**  
The Nios II EDS contains an evaluation version of the popular Micrium MicroC/OS-II RTOS. Product licenses are sold separately by Micrium.

## Join the Nios II Community!

Be one of the thousands of Nios II developers who visit the Altera Wiki, Altera Forum, and the [Rocketboards.org](http://Rocketboards.org) website. Altera Wiki and the [Rocketboards.org](http://Rocketboards.org) website have hundreds of design examples and design tips from Nios II developers all over the world. Join ongoing discussions on the Nios II section of the Altera Forum to learn more about Linux, hardware, and software development for the Nios II processor.

Visit the following websites:

[www.alterawiki.com](http://www.alterawiki.com)  
[www.alteraforum.com](http://www.alteraforum.com)  
[www.rocketboards.org](http://www.rocketboards.org)

## Development Kits

Go to [page 64](#) for information about embedded development kits.

# SoC FPGA OPERATING SYSTEM SUPPORT

Intel and our ecosystem partners offer comprehensive operating system support for Intel SoC FPGA development boards.

OPERATING SYSTEM	COMPANY
Abassi	Code Time Technologies
Android	MRA Digital
AUTOSAR MCAL	Intel
Bare-Metal/Hardware Libraries	Intel
Carrier Grade Edition 7 (CGE7)	MontaVista
DEOS	DDC-I
eCosPro	eCosCentric
eT-Kernel	eSOL
FreeRTOS	FreeRTOS.org
INTEGRITY RTOS	Green Hills Software
Linux	Open Source ( <a href="http://www.rocketboards.org">www.rocketboards.org</a> )
Nucleus	Mentor Graphics
OSE	Enea
PikeOS	Syngo
QNX Neutrino	QNX
RTEMS	RTEMS.org
RTXC	Quadros System
ThreadX	Express Logic
uC/OS-II, uC/OS-III	Micrium
uC3 (Japanese)	eForce
VxWorks	Wind River
Wind River Linux	Wind River
Windows Embedded Compact 7	Microsoft (Adeneo Embedded)

## More Information

For the latest on OS support for Intel SoCs, visit [www.altera.com/products/soc/ecosystem.html](http://www.altera.com/products/soc/ecosystem.html)

# NIOS II PROCESSOR OPERATING SYSTEM SUPPORT

Intel and our ecosystem partners offer comprehensive operating system support for the Nios II processor.

OS	AVAILABILITY
ChibiOS/RT	Now through <a href="http://www.emb4fun.com">www.emb4fun.com</a>
eCos	Now through <a href="http://www.ecoscentric.com">www.ecoscentric.com</a>
eCos (Zylin)	Now through <a href="http://www.opensource.zylin.com">www.opensource.zylin.com</a>
embOS	Now through <a href="http://www.segger.com">www.segger.com</a>
EUROS	Now through <a href="http://www.euros-embedded.com">www.euros-embedded.com</a>
FreeRTOS	Now through <a href="http://www.freertos.org">www.freertos.org</a>
Linux	Now through <a href="http://www.windriver.com">www.windriver.com</a>
Linux	Now through <a href="http://www.rocketboards.org">www.rocketboards.org</a>
oSCAN	Now through <a href="http://www.vector.com">www.vector.com</a>
TargetOS	Now through <a href="http://www.blunkmicro.com">www.blunkmicro.com</a>
ThreadX	Now through <a href="http://www.threadx.com">www.threadx.com</a>
Toppers	Now through <a href="http://www.toppers.jp">www.toppers.jp</a>
µC/OS-II, µC/OS-III	Now through <a href="http://www.micrium.com">www.micrium.com</a>
Zephyr	Now through <a href="https://www.zephyrproject.org/">https://www.zephyrproject.org/</a>

## SUMMARY OF NIOS II SOFT PROCESSORS

CATEGORY	PROCESSOR	VENDOR	DESCRIPTION
Power- and cost-optimized processing	Nios II economy core	Intel	With unique, real-time hardware features such as custom instructions, ability to use FPGA hardware to accelerate a function, vectored interrupt controller, and tightly coupled memory, as well as support for industry-leading RTOSs, the Nios II processor meets both your hard and soft real-time requirements, and offers a versatile solution for real-time processing.
Real-time processing	Nios II fast core <sup>1</sup>	Intel	
Applications processing	Nios II fast core	Intel	A simple configuration option adds a memory management unit to the Nios II fast processor core to support embedded Linux. Both open-source and commercially supported versions of Linux for Nios II processors are available.
Safety-critical processing	Nios II SC	HCELL	Certify your design for DO-254 compliance by using the Nios II Safety Critical core along with the DO-254 compliance design services offered by HCELL.

Notes:

1. With the Nios II Gen2 product the standard core is not available as a pre-configured option, however the Gen2 fast core can be configured in Qsys to have the same feature set as the standard core.

## Getting Started

To learn more about Intel's portfolio of customizable processors and how you can get started, visit [www.altera.com/nios](http://www.altera.com/nios).

# NIOS II PROCESSOR

In any of Intel's FPGAs, the Nios II processor offers a custom system solution that has the flexibility of software and the performance of hardware. Through its innovative design, the Nios II processor leverages the logic resources of the device to provide unprecedented hard and soft real-time capabilities.

You can also use the Nios II processor together with the ARM processor in Intel SoCs to create effective multi-processor systems.

With the Nios II processor you can:

- Lower overall system cost and complexity by integrating external processors into the FPGA.
- Scale performance with multiple processors, custom instructions (hardware acceleration of a software function), or co-processor modules (hardware accelerator next to the soft processor).
- Target any Stratix, Arria, Cyclone, MAX 10 FPGA, or the FPGA portion of the Arria V or Cyclone V SoCs.
- Eliminate the risk of processor and ASSP device obsolescence.
- Take advantage of the free Nios II economy core, the free Nios II Embedded Design Suite (EDS), and the free NicheStack TCP/IP Network Stack - Nios II Edition software to get started today.

## Nios II Processor Development Flow

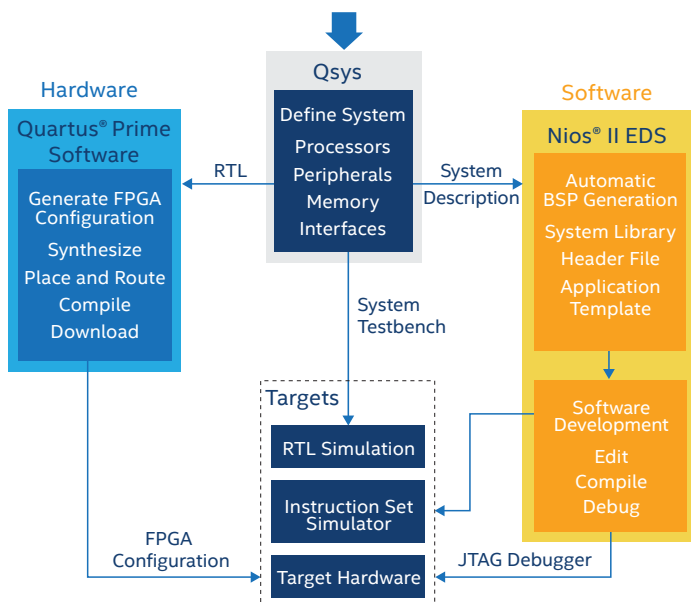

### Nios II Classic and Gen2 Processors

Nios II Gen2 processors are binary compatible improved versions of the Nios II Classic cores. Improvements include optional 32 bit address range, full ECC support, peripheral memory address region, and improved performance on some arithmetic instructions.

# INTEL'S CUSTOMIZABLE PROCESSOR PORTFOLIO

## PERFORMANCE AND FEATURE SET SUMMARY OF KEY PROCESSORS SUPPORTED ON INTEL FPGA DEVICES

CATEGORY	COST- AND POWER-SENSITIVE PROCESSORS	REAL-TIME PROCESSOR	APPLICATIONS PROCESSORS	
FEATURES	NIOS II ECONOMY	NIOS II FAST	28 NM <sup>1</sup> DUAL-CORE ARM CORTEX-A9	20 NM <sup>2</sup> DUAL-CORE ARM CORTEX-A9
Maximum frequency (MHz) <sup>3</sup>	420 (Stratix V)	350 (Stratix V)	925 MHz (Cyclone V SoC) 1.05 GHz (Arria V SoC)	1.5 GHz (Arria 10 -1 speed grade)
Maximum performance (MIPS <sup>4</sup> at MHz) Stratix series	54 (at 420 MHz)	385 (at 350 MHz)	–	–
Maximum performance (MIPS <sup>4</sup> at MHz) Arria series	43 (at 330 MHz)	315 (at 280 MHz)	2,625 MIPS per core at 1.05 GHz	3,750 MIPS per core at 1.5 GHz
Maximum performance (MIPS <sup>4</sup> at MHz) Cyclone series	26 (at 200 MHz)	185 (at 170 MHz)	2,313 MIPS per core at 925 MHz	–
Maximum performance efficiency (MIPS <sup>4</sup> per MHz)	0.13	1.1	2.5	2.5
16/32 bit instruction set support	32	32	16 and 32	16 and 32
Level 1 instruction cache	–	Configurable	32 KB	32 KB
Level 1 data cache	–	Configurable	32 KB	32 KB
Level 2 cache	–	–	512 KB	512 KB
Memory management unit	–	Configurable	✓	✓
Floating-point unit	–	FPH <sup>5</sup>	Dual precision	Dual precision
Vectored interrupt controller	–	✓	–	–
Tightly coupled memory	–	Configurable	–	–
Custom instruction interface	Up to 256	Up to 256	–	–
Equivalent LEs	600	1,800 – 3,200	HPS	HPS

Notes:

1. 28 nm SoCs comprise Cyclone V SoCs and Arria V SoCs.
2. 20 nm SoCs comprise Arria 10 SoCs.
3. Maximum performance measurements measured on Stratix V FPGAs.
4. Dhrystone 2.1 benchmark.
5. Floating-point hardware – Nios II custom instructions.

# INTEL AND DSN MEMBER FUNCTIONS

[www.altera.com/ip](http://www.altera.com/ip)

For a complete list of IP functions from Intel and its DSN members, please visit [www.altera.com/ip](http://www.altera.com/ip).

	PRODUCT NAME	VENDOR NAME	PRODUCT NAME	VENDOR NAME
DSN	<b>ARITHMETIC</b>		<b>VIDEO AND IMAGE PROCESSING</b>	
	Floating Point Megafunctions	Intel	Video and Image Processing Suite <sup>1</sup>	Intel
	Floating Point Arithmetic Co-Processor	Digital Core Design	HD JPEG 2000 Encoders/Decoders	IntoPIX
	Floating Point Arithmetic Unit	Digital Core Design	TICO Lightweight Video Compression	IntoPIX
	<b>ERROR DETECTION/CORRECTION</b>		Multi-Channel JPEG 2000 Encoder and Decoder Cores	Barco Silex
	Reed-Solomon Encoder/Decoder II <sup>1</sup>	Intel	VC-2 High Quality Video Decoder	Barco Silex
	Viterbi Compiler, High-Speed Parallel Decoder	Intel	VC-2 High Quality Video Encoder	Barco Silex
	Viterbi Compiler, Low-Speed/ Hybrid Serial Decoder	Intel	MPEG-2 TS Encapsulator/Decapsulator for SMPTE2022 1/2	IntoPIX
	Turbo Encoder/Decoder	Intel	JPEG Encoders	CAST, Inc.
	High-Speed Reed Solomon Encoder/Decoder	Intel	Ultra-fast, 4K-compatible, AVC/ H.264 Baseline Profile Encoder	CAST, Inc.
	BCH Encoder/Decoder	Intel	Low-Power AVC / H.264 Baseline Profile Encoder	CAST, Inc.
	Low-Density Parity Check Encoder/Decoder	Intel	H.265 Main Profile Video Decoder	CAST, Inc.
	Zip-Accel-C: GZIP/ZLIB/Deflate Data Compression Core	CAST, Inc.	H.265 Encoders	Jointwave Group LLC
	Zip-Accel-D: GUNZIP/ZLIP/Inflate Data Decompression Core	CAST, Inc.	H.264 Encoders	Jointwave Group LLC
	<b>FILTERS AND TRANSFORMS</b>		Video Processor and Deinterlacer with Line-Doubled Output	Crucial IP, Inc.
	Fast Fourier Transform (FFT)/ Inverse FFT (IFFT)	Intel	Configurable Cross Converter	Crucial IP, Inc.
	Cascaded Integrator Comb (CIC) Compiler	Intel	Video Scaler with Shrink and Zoom Support	Crucial IP, Inc.
	Finite Impulse Response (FIR) Compiler II	Intel	Mosquito / Block Noise Reducer	Crucial IP, Inc.
	SHA-1	CAST, Inc.	Adaptive Detail Enhancer	Crucial IP, Inc.
	SHA-256	CAST, Inc.	<b>32 BIT/16 BIT</b>	
	AES CODECS	CAST, Inc.	Nios II (Classic/Gen2) Embedded Processors <sup>1</sup>	Intel
	<b>MODULATION/DEMODULATION</b>		ARM Cortex-A9 MPCore Processor	Intel
	Numerically Controlled Oscillator Compiler	Intel	Hard Processor IP in Intel FPGA SoCs	Intel
	ATSC and Multi-Channel ATSC 8-VSB Modulators	Commsonic		
	DVB-T Modulator	Commsonic		
	DVB-S2 Modulator	Commsonic		
	Multi-Channel Cable (QAM) Modulator	Commsonic		
			<b>PROCESSORS AND PERIPHERALS</b>	

Notes:

1. Qsys-compliant licensed core.

## Intellectual Property

	PRODUCT NAME	VENDOR NAME
INTERFACE AND PROTOCOLS	<b>COMMUNICATION</b>	
	Optical Transport Network (OTN) Framers/Deframers	Intel
	SFI-5.1	Intel
	SDN CodeChips	Arrive Technologies
	SONET/SDH CodeChips	Arrive Technologies
	<b>ETHERNET</b>	
	Low-Latency 10 Gbps Ethernet Media Access Controller (MAC) <sup>1</sup> with 1588	Intel
	Triple-Speed Ethernet (10/100/1000 Mbps) MAC and PHY <sup>1</sup> with 1588 Option	Intel
	1 / 2.5 / 5 / 10G Multi-Rate PHY and Backplane Options	Intel
	10G Base-X (XAUI) PHY	Intel
	40G Ethernet MAC and PHY with 1588 and Backplane Options	Intel
	100G Ethernet MAC and PHY with 1588 and RS-FEC options	Intel
	25G MAC and PHY with RS-FEC option	Intel
	50G MAC and PHY	Intel
	1G/10Gb Ethernet PHY	Intel
	Carrier Ethernet CodeChips	Arrive Technologies
	Pseudowire CodeChips	Arrive Technologies
	High-Performance Gigabit Ethernet MAC <sup>1</sup>	IFI
	10 Gigabit Reduced XAUI PCS Core (RXAUI)	MorethanIP
	SPAUI MAC Core	MorethanIP
	20 Gigabit DXAUI PCS Core	MorethanIP
	QSGMII PCS Core	MorethanIP
	2.5 Gbps Ethernet MAC	MorethanIP

Notes:  
1. Qsys-compliant licensed core.

	PRODUCT NAME	VENDOR NAME
INTERFACE AND PROTOCOLS (CONTINUED)	<b>HIGH SPEED</b>	
	JESD204B	Intel
	RapidIO* <sup>1</sup> Gen1, Gen2	Intel
	Common Public Radio Interface (CPRI)	Intel
	Interlaken	Intel
	Interlaken Look-Aside	Intel
	QuickPath Interconnect (QPI)	Intel
	SerialLite II/III	Intel
	SATA 1.0/SATA 2.0	Intelliprop, Inc.
	RapidIO Gen3	Mobiveil
	QDR Infiniband Target Channel Adapter	Polybus
	<b>PCIe / PCI</b>	
	PCIe Gen1 x1 <sup>1</sup> , x4 <sup>1</sup> , x8 <sup>1</sup> Controller (Soft IP)	Intel
	PCIe Gen1, Gen2, Gen3 Core x1, x2, x4, and x8 (Hardened IP)	Intel
	PCI 32/64 bit PCI Master Target 33/66 MHz Controllers	CAST, Inc.
	PCI Multifunction Master/Target Interface	CAST, Inc.
	Expresso 3.0 PCI Express Core (Gen 1 - 3)	Northwest Logic, Inc.
	PCI Express Multiport Transparent Switch	Mobiveil, Inc.
	PCI Express Hybrid Controller	Mobiveil, Inc.
	PCI Express to AXI Bridge Controller	Mobiveil, Inc.
	PCI-X Core	Northwest Logic, Inc.
	PCI Core	Northwest Logic, Inc.
	XpressRICH3 PCIe Gen1, Gen2, and Gen3	PLDA
	PCI and PCI-X Master/Target Cores 32/64 bit	PLDA

	PRODUCT NAME	VENDOR NAME
INTERFACE AND PROTOCOLS (CONTINUED)	<b>SERIAL</b>	
	Serial Peripheral Interface (SPI)/ Avalon <sup>®</sup> Master Bridge <sup>2</sup>	Intel
	UART <sup>2</sup>	Intel
	JTAG UART <sup>2</sup>	Intel
	16550 UART	Intel
	JTAG/Avalon Master Bridge <sup>2</sup>	Intel
	CAN 2.0/FD <sup>1</sup>	CAST, Inc.
	Local Interconnect Network (LIN) Controller	CAST, Inc.
	H16550S UART	CAST, Inc.
	MD5 Message-Digest	CAST, Inc.
	Smart Card Reader	CAST, Inc.
	DI2CM I <sup>2</sup> C Bus Interface-Master	Digital Core Design
	DI2CSB I <sup>2</sup> C Bus Interface-Slave	Digital Core Design
	D16550 UART with 16-Byte FIFO	Digital Core Design
	DSPI Serial Peripheral Interface Master/Slave	Digital Core Design
	Secure Digital (SD)/MMC SPI	El Camino GmbH
	Secure Digital I/O (SDIO)/SD Memory/Slave Controller	Eureka Technology, Inc.
	SDIO/SD Memory/ MMC Host Controller	Eureka Technology, Inc.
	Nios II Advanced CAN <sup>1</sup>	IFI
	I <sup>2</sup> C Master/Slave/PIO Controller	Microtronix, Inc.
	I <sup>2</sup> C Master and Slave	SLS
	USB High-Speed Function Controller <sup>1</sup>	SLS
	USB Full-/Low-Speed Function Controller <sup>1</sup>	SLS
	Embedded USB 3.0 / 3.1 Gen 1 Host and Device Controllers	SLS
	USB 3.0 SuperSpeed Device Controller	SLS

## Notes:

1. Qsys-compliant licensed core.
2. Qsys component (no license required).

	PRODUCT NAME	VENDOR NAME	
INTERFACE AND PROTOCOLS (CONTINUED)	<b>AUDIO AND VIDEO</b>		
	Character LCD <sup>2</sup>	Intel	
	Pixel Converter (BGR0 to BGR) <sup>2</sup>	Intel	
	Video Sync Generator <sup>2</sup>	Intel	
	SD/HD/3G-HD Serial Digital Interface (SDI)	Intel	
	DisplayPort 1.1 and 1.2	Intel	
	HDMI 1.4 and 2.0	Intel	
	Bitec HDMI 2.0a IP core	Bitec	
	DisplayPort 1.3 IP Core	Bitec	
	HDCP IP Core	Bitec	
	AC'97 Controller	SLS	
	MEMORIES AND MEMORY CONTROLLERS	<b>DMA</b>	
		Scatter-Gather DMA Controller <sup>2</sup>	Intel
DMA Controller <sup>2</sup>		Intel	
DMA Controllers		Eureka Technology, Inc.	
Lancero Scatter-Gather DMA Engine for PCI Express		Microtronix, Inc.	
AXI* DMA back-End Core		Northwest Logic, Inc.	
Expresso DMA Bridge Core		Northwest Logic, Inc.	
Express DMA Core		Northwest Logic, Inc.	
<b>FLASH</b>			
CompactFlash (True IDE) <sup>2</sup>		Intel	
EPCS Serial Flash Controller <sup>2</sup>		Intel	
Flash Memory <sup>2</sup>		Intel	
NAND Flash Controller		Eureka Technology, Inc.	
Universal NVM Express Controller (UNEX)	Mobiveil, Inc.		
ONFI Controller	SLS		
Enhanced ClearNAND Controller	SLS		



	PRODUCT NAME	VENDOR NAME
MEMORIES AND MEMORY CONTROLLERS (CONTINUED)	<b>SDRAM</b>	
	DDR/DDR2 and DDR3/DDR4 SDRAM Controllers <sup>1</sup>	Intel
	LPDDR2 SDRAM Controller	Intel
	RLDRAM 2 Controller	Intel
	Hybrid Memory Cube Controller	Intel
	Streaming Multi-Port SDRAM Memory Controller	Microtronix, Inc.
	HyperDrive Multi-Port DDR2 Memory Controller	Microtronix, Inc.
	Avalon Multi-Port SDRAM Memory Controller <sup>1</sup>	Microtronix, Inc.
	RLDRAM II and III Controllers	Northwest Logic, Inc.
	LPDDR2/3 Controllers	Northwest Logic, Inc.
	<b>SRAM</b>	
	SSRAM (Cypress CY7C1380C) <sup>2</sup>	Intel
	QDR II/II+/II+Xtreme/IV SRAM Controller	Intel

Notes:

1. Qsys-compliant licensed core.
2. Qsys component (no license required).

# TRANSCEIVER PROTOCOLS

[www.altera.com/transceiver\\_protocols](http://www.altera.com/transceiver_protocols)

Intel device transceivers support the protocols listed in the following table. For details about the data rates, please visit [www.altera.com/transceiver\\_protocols](http://www.altera.com/transceiver_protocols).

PROTOCOLS/ INTERFACE STANDARDS	SUPPORTED DEVICES															
	STRATIX SERIES FPGAs						ARRIA SERIES FPGAs							CYCLONE SERIES FPGAs		
	10 GX/SX	V GX/GS	V GT	IV GX	IV GT	II GX	10 GX/SX	10 GT	V GX	V GT/ST	V GZ	II GX	II GZ	V GX/SX	V GT/ST	IV GX
Basic (proprietary)	✓	✓	✓	✓	✓	✓	✓	✓	✓	✓	✓	✓	✓	✓	✓	✓
CEI-6G-SR/LR	✓	✓	✓	✓	✓	✓	✓	✓	✓	✓	✓	-	-	-	-	-
CEI-11G-SR	✓	✓	✓	-	✓	-	✓	✓	-	-	-	-	-	-	-	-
CEI-28G-VSR	✓	-	✓	-	-	-	-	✓	-	-	-	-	-	-	-	-
SFP+/SFF-8431	✓	✓	✓	-	✓	-	✓	✓	-	-	✓	-	-	-	-	-
XFI	✓	✓	✓	-	✓	-	✓	✓	-	✓	-	-	-	-	-	-
XFP	✓	✓	✓	-	-	-	✓	✓	-	-	✓	-	-	-	-	-
1000BASE-X (GbE)	✓	✓	✓	✓	✓	✓	✓	✓	✓	✓	✓	✓	✓	✓	✓	✓
10GBASE-R	✓	✓	✓	-	✓	-	✓	✓	-	✓	✓	-	-	-	-	-
10GBASE-KR	✓	✓	✓	-	-	-	✓	✓	-	-	✓	-	-	-	-	-
ASI	✓	✓	✓	✓	✓	✓	✓	✓	✓	✓	-	✓	✓	-	-	-
CPRI	✓	✓	✓	✓	✓	✓	✓	✓	✓	✓	✓	✓	✓	✓	✓	✓
CAUI/XLAUI	✓	✓	✓	-	✓	-	✓	✓	-	-	✓	-	-	-	-	-
CAUI-4	✓	-	✓	-	-	-	-	✓	-	-	-	-	-	-	-	-
DisplayPort	✓	✓	✓	✓	✓	✓	✓	✓	✓	✓	✓	-	-	✓	✓	✓
Fibre Channel	✓	✓	✓	✓	✓	✓	✓	✓	-	✓	✓	-	-	-	-	-
GPON	✓	✓	✓	✓	✓	-	✓	✓	✓	✓	✓	✓	✓	-	-	-
G.709 OTU-2	✓	✓	✓	-	✓	-	✓	✓	✓	✓	-	-	-	✓	✓	✓
OTN with FEC	✓	✓	✓	-	✓	-	✓	✓	-	-	-	-	-	-	-	-
HiGig	✓	✓	✓	✓	✓	✓	✓	✓	✓	✓	✓	✓	✓	-	-	-
High-Definition Multimedia Interface (HDMI)	✓	✓	✓	✓	✓	✓	✓	✓	✓	✓	✓	✓	✓	✓	✓	✓

## Protocols







PROTOCOLS	SUPPORTED DEVICES															
	STRATIX SERIES FPGAs						ARRIA SERIES FPGAs						CYCLONE SERIES FPGAs			
	10 GX/SX	V GX/GS	V GT	IV GX	IV GT	II GX	10 GX/SX	10 GT	V GX	V GT/ST	V GZ	II GX	II GZ	V GX/SX	V GT/ST	IV GX
JESD204 A/B	✓	✓	✓	✓	✓	✓	✓	✓	✓	✓	✓	✓	✓	✓	✓	✓
HMC <sup>1</sup>	✓	-	-	-	-	-	✓	✓	-	-	-	-	-	-	-	-
HyperTransport	✓	✓	✓	✓	✓	-	✓	✓	✓	✓	✓	-	-	-	-	-
InfiniBand	✓	✓	✓	-	-	-	✓	✓	-	-	✓	-	-	-	-	-
Interlaken	✓	✓	✓	✓	✓	-	✓	✓	✓	✓	✓	-	-	-	-	-
Interlaken Look-Aside	✓	✓	✓	-	-	-	✓	✓	✓	✓	✓	-	-	-	-	-
MoSys	✓	✓	-	-	-	-	✓	✓	-	-	-	-	-	-	-	-
OBSAI	✓	✓	✓	✓	✓	✓	✓	✓	✓	✓	✓	✓	✓	✓	✓	✓
PCI Express	✓	✓	✓	✓	✓	✓	✓	✓	✓	✓	✓	✓	✓	✓	✓	✓
RXAUI/DXAUI	✓	✓	✓	✓	✓	✓	✓	✓	✓	✓	✓	-	-	-	-	-
SGMII/QSGMII	✓	✓	✓	✓	✓	✓	✓	✓	✓	✓	✓	✓	✓	✓	✓	✓
QPI	✓	✓	✓	-	-	-	✓	✓	-	-	✓	-	-	-	-	-
SAS/SATA	✓	✓	✓	✓	✓	-	✓	✓	✓	✓	✓	✓	✓	✓	✓	✓
SerialLite II	✓	✓	✓	✓	✓	-	✓	✓	✓	✓	-	✓	✓	✓	✓	-
SerialLite III	✓	✓	✓	-	-	-	✓	✓	-	-	✓	-	-	-	-	-
SDI	✓	✓	✓	✓	✓	✓	✓	✓	✓	✓	✓	✓	✓	✓	✓	✓
SFI-5.1	✓	✓	✓	✓	✓	✓	✓	✓	✓	✓	✓	-	-	-	-	-
SFI-S/SFI-5.2	✓	✓	✓	-	✓	-	✓	✓	-	-	✓	-	-	-	-	-
RapidIO	✓	✓	✓	✓	✓	✓	✓	✓	✓	✓	✓	✓	✓	✓	✓	✓
SPAUI	✓	✓	✓	✓	✓	✓	✓	✓	-	-	✓	-	-	-	-	-
SONET/SDH	✓	✓	✓	✓	✓	✓	✓	✓	✓	✓	✓	✓	✓	-	-	-
XAUI (10GBASE-X)	✓	✓	✓	✓	✓	✓	✓	✓	✓	✓	✓	✓	✓	✓	✓	✓
V-by-One	✓	✓	✓	✓	✓	✓	✓	✓	✓	✓	-	-	-	-	-	✓

Notes:  
1. Contact Intel for more details on HMC support.

# INTEL FPGA AND PARTNER DEVELOPMENT KITS







[www.altera.com/devkits](http://www.altera.com/devkits)

Intel FPGA development kits provide a complete, high-quality design environment for engineers. These kits help simplify the design process and reduce time to market. Development kits include software, reference designs, cables, and programming hardware. Intel FPGA and partner development kits are listed below. For more details about these development kits or other older development kits that are available, check out our online development kits page at [www.altera.com/devkits](http://www.altera.com/devkits).

PRODUCT AND VENDOR NAME	DESCRIPTION
<b>ARRIA 10 FPGA KITS</b>  Arria 10 FPGA Development Kit Intel 	This kit provides a complete design environment including hardware and software for prototyping and testing high-speed serial interfaces to an Arria 10 GX FPGA. This kit includes the PCIe x8 form factor, two FMC connectors for expandability, Ethernet, USB, and SDIs. The board includes one HiLo connector for plugging in DRAM and SRAM daughtercards. Supported daughtercard formats include DDR4 x72 SDRAM, DDR3 x72 SDRAM, RLDRAM 3 x36, and QDR IV x36 SRAM. The board includes SMA connectors for transceiver output, clock output, and clock input. Several programmable oscillators are available and other user interfaces include user push buttons, dual in-line package (DIP) switches, bi-color user LEDs, an LCD display, power, and temperature measurement circuitry. This development kit comes with a one-year license for the Quartus Prime design software.
Arria 10 FPGA Signal Integrity Kit Intel 	This kit enables a thorough evaluation of transceiver signal integrity and device interoperability. Features include six full-duplex transceiver channels with 2.4 mm SMA connectors, four full-duplex transceiver channels to Amphenol Xcede+ backplane connector, four full-duplex transceiver channels to C form factor pluggable (CFP2) optical interface, four full-duplex transceiver channel to quad small form factor pluggable (QSFP+) optical interface, one transceiver channel to SFP+ optical interface, and ten full-duplex transceiver channels to Samtec BullsEye high-density connector. This board also includes several programmable clock oscillators, user pushbuttons, DIP switches, user LEDs, a 7-segment LCD display, power and temperature measurement circuitry, Ethernet, an embedded USB-Blaster II, and JTAG interfaces. This development kit comes with a one-year license for the Quartus Prime design software.
Arria 10 SoC Development Kit Intel 	The Arria 10 SoC Development Kit offers a quick and simple approach for developing custom ARM processor-based SoC designs. The Arria 10 SoCs offers full software compatibility with previous generation SoCs, a broad ecosystem of ARM software and tools, and an enhanced FPGA and DSP hardware design flow. This kit includes an Arria 10 10AS066N3F40I2SG SoC, PCIe Gen3 protocol support, a dual FPGA mezzanine card (FMC) expansion headers, two 10/100/1000 SGMII Ethernet ports, one 10/100/1000 RGMII Ethernet port, two 10GbE small form factor pluggable (SFP) cages, two 1GB DDR4 HPS HiLo memory card, DDR4 SDRAM, NAND, quad SPI, SD/MICRO boot flash cards, character LCD, display port, and SDI port.
Attila Instant-Development Kit Arria 10 FPGA FMC IDK ReFLEX 	The Arria 10 FPGA FMC Instant-Development Kit provides the best out-of-the-box experience, combining the best-in-class compact hardware platform and the most efficient intuitive software environment.
Alaric Instant-Development Kit Arria 10 SoC FMC IDK ReFLEX 	The Arria 10 SoC FMC Instant-Development Kit provides the best out-of-the-box experience, combining the best-in-class compact hardware platform and the most efficient intuitive software environment.
Nallatech 510T Nallatech 	The Nallatech 510T is an FPGA co-processor that is designed to deliver ultimate performance per watt for compute-intensive data center applications. The 510T is a GPU-sized 16-lane PCIe Gen3 card featuring two of Intel's new floating-point enabled Arria 10 FPGAs delivering up to 16 times the performance of the previous generation. Applications can achieve a total sustained performance of up to 3 TFLOPS.

Note:

This board also has a MAX 10 FPGA on it to do board management, such as power sequencing and monitoring, and thermal management.

PRODUCT AND VENDOR NAME	DESCRIPTION
<b>MAX 10 FPGA KITS</b>  MAX 10 NEEK <b>Terasic</b> 	<p>The MAX 10 Nios II Embedded Evaluation Kit (NEEK) is a full featured embedded evaluation kit based on the MAX 10 family of FPGAs. The MAX 10 NEEK delivers an integrated platform that includes hardware, design tools, IP, and reference designs for developing a wide range of applications. This kit allows developers to rapidly customize their processor and IP to suit their specific needs, rather than constraining their software around the fixed feature set of the processor. The kit features a capacitive LCD multimedia color touch panel, which natively supports multi-touch gestures. An eight megapixel digital image sensor, ambient light sensor, and three-axis accelerometer make up this rich feature set, along with a variety of interfaces connecting the MAX 10 NEEK to the outside for Internet of Things (IoT) applications across markets.</p>
MAX 10 FPGA Development Kit <b>Intel</b> 	<p>This kit offers a comprehensive general-purpose development platform for many markets and applications, such as industrial and automotive. This fully featured development kit includes a 10M50DAF484C6G device, DDR3 memory, 2X 1 GbE, high-speed mezzanine card (HSMC) connector, quad serial peripheral interface, 16 bit digital-to-analog converter (DAC), flash memory, and 2X Digilent Pmod* Compatible headers.</p>
MAX 10 FPGA Evaluation Kit <b>Intel</b> 	<p>The 10M08 evaluation board provides a cost-effective entry point to MAX 10 FPGA design. The card comes complete with an Arduino header socket, which lets you connect a wide variety of daughtercards. Other features include a MAX 10 10M08SAE144C8G device, Arduino shield expansion, access to 80 I/O through-holes, and a prototyping area.</p>
BeMicro MAX 10 FPGA Evaluation Kit <b>Arrow</b> 	<p>The BeMicro MAX 10 FPGA evaluation kit is an entry-level kit from Arrow that includes a 10M08DAF484C8G device. The kit retains the 80-pin edge connector interface used on previous BeMicro kits. The BeMicro MAX 10 FPGA evaluation kit includes a variety of peripherals, such an accelerometer, DAC, temperature sensor, thermal resistor, photo resistor, LEDs, pushbuttons, and several different options for expansion connectivity, including 2X Digilent Pmod Compatible headers and 2X 40-pin prototype headers.</p>
DECA MAX 10 FPGA Evaluation Kit <b>Arrow</b> 	<p>DECA is a full-featured evaluation kit featuring a 10M50DAF484C6G device. The kit includes a BeagleBone-compatible header for further I/O expansion, a variety of sensors (gesture/humidity/ temperature/CMOS), MIPI CSI-2 camera interface, LEDs, pushbuttons, and an on-board USB-Blaster II cable.</p>
Mpression Odyssey MAX 10 FPGA IoT Evaluation Kit <b>Macnica</b> 	<p>The Macnica MAX 10 FPGA evaluation kit connects and controls your FPGA design via Bluetooth using the Mpression Odyssey Smartphone application. This kit also includes a 10M08U169C8G device, SDRAM, Arduino shield expansion capability, and Bluetooth SMART connectivity module.</p>
<b>STRATIX V FPGA KITS</b>	
Stratix V Advanced Systems Development Kit <b>Intel</b>	<p>This kit is a complete systems design environment that includes both the hardware and software needed to begin architecture development and system design using Stratix V FPGAs. The PCIe-based form factor utilizes a x16 edge connector, and includes high memory bandwidth to DDR3, QDR II+, and serial memory. Multiple high-speed protocols are accessible through FMC and HSMC connections.</p>
Stratix V GX FPGA Development Kit <b>Intel</b>	<p>This kit provides a full-featured hardware development platform for prototyping and testing high-speed serial interfaces to a Stratix V GX FPGA. This kit includes the PCIe x8 form factor, two HSMC connectors for expandability, and Ethernet, USB, and SDI interfaces. Memory includes one x72 DDR3 SDRAM, one x18 QDR II+ SRAM, and flash memory. This kit also includes two SMA connectors for a differential transceiver output. Several programmable oscillators are available and other user interfaces include three user pushbuttons, eight DIP switches, eight bi-color user LEDs, an LCD display, and power and temperature measurement circuitry.</p>
Transceiver Signal Integrity Development Kit, Stratix V GX Edition <b>Intel</b>	<p>This kit enables a thorough evaluation of transceiver signal integrity and device interoperability. Features include seven full-duplex transceiver channels with SMA connectors, two 14G backplane connectors (from Amphenol and Molex), four programmable clock oscillators, four user pushbuttons, eight DIP switches, eight user LEDs, a 7-segment LCD display, power and temperature measurement circuitry, and Ethernet, an embedded USB-Blaster download cable, and JTAG interfaces.</p>

PRODUCT AND VENDOR NAME	DESCRIPTION
<b>STRATIX V FPGA KITS (CONTINUED)</b>  Transceiver Signal Integrity Development Kit, Stratix V GT Edition <b>Intel</b>	The Intel Stratix V GT Transceiver Signal Integrity Development Kit provides a platform for electrical compliance testing and interoperability analysis. The accessibility to multiple channels allows for real-world analysis as implemented in the system with transceiver channels available through SMA and popular backplane connectors. This development kit can be used for evaluation of transceiver link performance up to 28 Gbps, generation and checking pseudo-random binary sequence (PRBS) patterns via an easy-to-use GUI that does not require the Quartus Prime software, access advanced equalization to fine-tune link settings for optimal bit error ratio (BER), jitter analysis, and verifying physical media attachment (PMA) interoperability with Stratix V GT FPGAs for targeted protocols, such as CEI-25/28G, CEI-11G, PCIe Gen 3.0, 10GBASE-KR, 10 Gigabit Ethernet, XAUI, CEI-6G, Serial RapidIO, HD-SDI, and others. You can use the built-in high speed backplane connectors to evaluate custom backplane performance and evaluate link BER.
100G Development Kit, Stratix V GX Edition <b>Intel</b>	This kit enables a thorough evaluation of 100G designs. It supports 10G/40G line interfaces through optical modules, and applications requiring external memory interfaces through four x18 QDR II and four x32 DDR3 memory banks. With this kit, you can evaluate transceiver performance up to 11.3 Gbps, and verify PMA compliance to standards, such as 10G/40G/100G Ethernet, Interlaken, CEI-6G/11G, Serial RapidIO, PCIe (Gen1, Gen2, and Gen3), and other major standards. This kit can also validate interoperability between optical modules, such as SFP, SFP+, QSFP, and CFP.
DSP Development Kit, Stratix V Edition <b>Intel</b>	The DSP Development Kit, Stratix V Edition provides a complete design environment that includes all the hardware and software you need to begin developing DSP intensive FPGA designs immediately. The development kit is RoHS-compliant. You can use this development kit to develop and test PCIe designs at data rates up to Gen3, develop and test memory subsystems for DDR3 SDRAM or QDR II SRAM memories, and use the HSMC connectors to interface to one of over 35 different HSMCs provided by Intel partners, supporting protocols such as Serial RapidIO, 10 Gbps Ethernet, SONET, Common Public Radio Interface (CPRI), OBSAI, and others.
S5-6U-VPX (S56X) <b>BittWare</b>	This rugged 6U VPX card is based on Intel's Stratix V GX or GS FPGAs. When combined with BittWare's Anemone FPGA coprocessor, the ARM Cortex-A8 control processor, and the ATLANTiS FrameWork FPGA development kit, it creates a flexible and efficient solution for high-performance signal processing and data acquisition. The board provides a configurable 48-port multi-gigabit transceiver interface supporting a variety of protocols, including Serial RapidIO, PCIe, and 10GbE. Additional I/O interfaces include Ethernet, RS-232, JTAG, and LVDS. The board features up to 8 GB of DDR3 SDRAM as well as flash memory for booting the FPGAs. Two VITA 57-compliant FMC sites provide additional flexibility for enhancing the board's I/O and processing capabilities.
S5-PCIe-HQ (S5PH-Q) <b>BittWare</b>	This half-length PCIe x8 card is based on Intel's Stratix V GX or GS FPGA and is a versatile and efficient solution for high-performance network processing, signal processing, and data acquisition. Combining it with BittWare's Anemone coprocessor and ATLANTiS FrameWork enhances productivity and portability, and allows even greater processing efficiency. Over 16 GB of onboard memory includes DDR3 SDRAM and QDR II/III+ SRAM. Two front-panel QSFP+ cages provide additional flexibility for serial I/O, allowing two 40GbE interfaces (or eight 10GbE), direct to the FPGA for reduced latency, making it ideal for high-frequency trading and networking applications.
S5-PCIe (S5PE) <b>BittWare</b>	This PCIe x8 card is based on Intel's Stratix V GX or GS FPGA and is designed for high-performance network processing, signal processing, and data acquisition. Combining it with BittWare's Anemone coprocessor and ATLANTiS FrameWork enhances productivity and portability and allows even greater processing efficiency. The board provides up to 32 GB of DDR3 SDRAM with optional ECC. An optional VITA 57 FMC site provides additional flexibility for enhancing the board's I/O and processing capabilities, making it ideal for analog I/O and processing. The board also has the option of two front-panel QSFP+ cages for serial I/O, which support 10G per lane direct to the FPGA for reduced latency, making it ideal for high-frequency trading and networking applications. It is also available with A/D and D/A conversion options.
ProcHILs <b>GiDel</b>	This kit is based on Intel's Stratix V and Stratix IV FPGA. This development kit provides a state-of-the-art Hardware in the Loop acceleration tool for running Simulink designs on Intel FPGAs. ProcHILs can automatically translate Simulink designs built using DSP Builder for Intel FPGAs into FPGA code and run this code under Simulink. The generated code is compatible with the Proc board installed on the target PC and has the synchronization code needed to communicate with Simulink via PCIe.

PRODUCT AND VENDOR NAME	DESCRIPTION
<b>STRATIX V FPGA KITS (CONTINUED)</b>	
ProceV GiDel	This half-length PCIe x8 card is based on Intel's Stratix V GX or GS FPGA and is a versatile and efficient solution for high-performance network processing, signal processing, and data acquisition. Combining it with GiDEL's PROCWizard software and data management IP cores enhances productivity and portability, and allows even greater processing efficiency. The platform features 16+ GB of onboard memory that includes DDR3 SDRAM and SRAM. Typical sustainable throughput is 8,000 GBps for internal memories and 25+ GBps for onboard memory. Networking capabilities include one CXP connector cage suitable for 100GbE Ethernet (100GBASE-CR10, 100GBASE-SR10), 3×40 GbE, or single Infiniband 12×QDR link, two SFP+ cage suitable for 10 GbE, and Optical Transport Network. Additional I/O interfaces, 2× high-speed inter-board connectors (up to 12×14.1 Gbps full duplex GPIO) for board-to-board and proprietary daughterboards connectivity.
ProcFG GiDel	This kit is based on Intel's Stratix V GX and Stratix IV E FPGA. It is used for development of vision algorithms, machine vision, and medical imaging applications. ProcFG combines high-speed acquisition and powerful FPGA processing with selective on-the-fly region of interest (ROI) offloading for convenient processing on standard PCs. The ProcFG captures all incoming image data or dynamically targets and extracts ROIs based on real-time FPGA analysis of the incoming data, and supports acquisition from both line and area scan cameras.
<b>ARRIA V FPGA AND SoC KITS</b>	
Arria V GX FPGA Development Kit, Arria V GX Edition Intel	This kit provides a full-featured hardware development platform for prototyping and testing high-speed serial interfaces to an Arria V GX FPGA. This kit includes two Arria V 5AGXFB3H6F40C6N FPGAs, the PCIe x8 form factor, two HSMC connectors, one FPGA mezzanine card (FMC) connector, 1,152 MB 72 bit DDR3 SDRAM, 4 MB 36 bit QDR II+ SRAM, flash memory, and two additional 32 bit DDR3 SDRAM devices. This kit also includes SMA connectors and a bull's-eye connector for differential transceiver I/Os.
Arria V GX Starter Kit, Arria V GX Edition Intel	This kit provides a low-cost platform for developing transceiver I/O-based Arria V GX FPGA designs. This kit includes the PCIe x8 form factor, one HSMC connector, a 32 bit DDR3 SDRAM device, one-channel high-speed transceiver input and output connected to SMAs, HDMI output, SDI input and output, 16x2 LCD display, and flash memory.
Arria V SoC Development Kit and SoC Embedded Design Suite Intel	The Intel Arria V SoC Development Kit offers a quick and simple approach to develop custom ARM processor-based SoC designs. Intel's midrange, transceiver-based Arria V FPGA fabric provides the highest bandwidth with the lowest total power for midrange applications such as remote radio units, 10G/40G line cards, medical imaging, broadcast studio equipment, and the acceleration of image- and video-processing applications. This development kit includes the SoC Embedded Design Suite software development tools. The development board has PCIe Gen2 x4 lanes (endpoint or rootport), two FMC expansion headers, dual Ethernet PHYs, and various DRAM and flash memories.
<b>CYCLONE V FPGA AND SoC KITS</b>	
Cyclone V E FPGA Development Kits Intel	The Cyclone V E Development Kit offers a comprehensive general-purpose development platform for many markets and applications, including industrial, networking, military, and medical applications. The kit features an Intel Cyclone V device and a multitude of onboard resources including multiple banks of DDR3 and LPDDR2 memory, LCD character display, LEDs, user switches, USB, and RJ-45 connectors. The Cyclone V E FPGA Development Kit gives industrial equipment designers greater flexibility in implementing real-time Ethernet communications with industrial Ethernet IP cores.
Cyclone V GT FPGA Development Kit Intel	This kit can be used to prototype Cyclone V GT FPGA or Cyclone V GX FPGA applications. It offers a quick and simple way to develop low-cost and low-power system-level designs and achieve rapid results. This kit supports a myriad of functionalities, such as FPGA prototyping, FPGA power measurement, transceiver I/O performance up to 5 Gbps, PCIe Gen2 x4 (at 5 Gbps per lane), endpoint or rootport support.

PRODUCT AND VENDOR NAME	DESCRIPTION
<b>CYCLONE V FPGA AND SoC KITS (CONTINUED)</b>	
Cyclone V SoC Development Kit <b>Intel</b>	The Cyclone V SoC Development Kit offers a quick and simple approach to develop custom ARM processor-based SoC designs accompanied by Intel's low-power, low-cost Cyclone V FPGA fabric. This kit supports a wide range of functions, such as processor and FPGA prototyping and power measurement, industrial networking protocols, motor control applications, acceleration of image- and video-processing applications, PCIe x4 lane with ~1,000 MBps transfer rate (endpoint or rootport).
Cyclone V GX Starter Kit <b>Terasic Technologies</b>	The Cyclone V GX Starter Kit offers a robust hardware design platform based on Cyclone V GX FPGA. This kit is optimized for the lowest cost and power requirement for transceiver applications with industry-leading programmable logic for ultimate design flexibility. The Cyclone V Starter Kit development board includes hardware, such as Arduino Header, on-board USB-Blaster circuit, audio and video capabilities, and an on-board HSMC connector with high-speed transceivers that allows for an even greater array of hardware setups.
Atlas-SoC Development Platform <b>Terasic Technologies</b>	The Atlas-SoC Kit combines a robust, Cyclone V SoC-based development board and interactive reference designs into a powerful development platform. This low-cost kit is an interactive, web-based guided tour that lets you quickly learn the basics of SoC development and provides an excellent platform on which to develop your own design. The board includes a Gigabit Ethernet port, USB 2.0 OTG port, SD card flash, 1 GB DDR3 SDRAM, an Arduino header, two 40-pin expansion headers, on-board USB-Blaster circuit, 8-channel A/D converter, accelerometer, and much more.
BeMicro CV <b>Arrow</b>	BeMicro CV adopts Intel's 28 nm, low-cost Cyclone V FPGA. It retains all the benefits of its predecessor including the 80-pin edge connector interface. Users can migrate their designs from BeMicro SDK to BeMicro CV easily. BeMicro CV supports more user GPIOs and a hard memory controller for DDR3 SDRAM.
Cyclone V Development Board <b>EBV Elektronik GmbH and Co. KG</b>	The DB5CGXFC7 board is based on the Cyclone V GX device providing PCIe and SPF cages for the transceivers, 32 bit width DDR3 memory and a quad SPI configuration device for active serial configuration. Two 100 Mb Ethernet PHYs and one Gigabit PHY is available for communication purposes, as well as two CAN transceiver and two RS485 transceivers. 43 GPIO signals are available on pin header four buttons, a DIP switch and eight LEDs are available for debug purposes. Host connection can be done with the implemented embedded USB-Blaster II or via the normal JTAG connector.
<b>MAX V CPLD KITS</b>	
MAX V CPLD Development Kit <b>Intel</b>	This low-cost platform will help you quickly begin developing low-cost, low-power CPLD designs. Use this kit as a stand-alone board or combined with a wide variety of daughtercards that are available from third parties.
<b>STRATIX IV FPGA KITS</b>	
Stratix IV GX FPGA Development Kit <b>Intel</b>	This kit provides a full-featured hardware development platform for prototyping and testing high-speed serial interfaces to a Stratix IV GX FPGA. This kit includes the PCIe x8 form factor, two HSMC connectors for expandability, and Ethernet, USB, SDI, and HDMI interfaces. Memory includes one x64 DDR3 SDRAM, one x16 DDR3 SDRAM, two x18 QDR II+ SRAM, flash, and SSRAM. This kit also includes two SMA connectors for a differential transceiver output. Several oscillators are available at 156.25 MHz, 155.52 MHz, 125 MHz, 100 MHz, and 50 MHz. Other user interfaces include six user pushbuttons, eight DIP switches, eight user LEDs, 7-segment LCD display, and power and temperature measurement circuitry.
Stratix IV GX FPGA Development Kit, 530 Edition <b>Intel</b>	This kit provides a full-featured hardware development platform for prototyping and testing high-speed serial interfaces to a Stratix IV GX FPGA. This kit includes the PCIe x8 form factor, two HSMC connectors for expandability, and Ethernet, USB, SDI, and HDMI interfaces. Memory includes one x64 DDR3 SDRAM, one x16 DDR3 SDRAM, two x18 QDR II+ SRAM, flash, and SSRAM. This kit also includes two SMA connectors for a differential transceiver output. Several oscillators are available at 156.25 MHz, 155.52 MHz, 125 MHz, 100 MHz, and 50 MHz. Other user interfaces include six user pushbuttons, eight DIP switches, eight user LEDs, 7-segment LCD display, and power and temperature measurement circuitry.
Stratix IV E FPGA Development Kit <b>Intel</b>	This kit allows rapid and early development of designs for high-performance Stratix IV FPGAs. The development board provides general I/Os that connect to onboard switches and indicators, and to the included two-line LCD and 128 x 64 graphics display. The board also has non-volatile and volatile memories (64 MB flash, 4 MB pseudo-SRAM, 36 Mb QDR II SRAM, 128 MB DDR2 DIMM, and 16 MB DDR2 device), HSMC, and 10/100/1000 Ethernet interfaces. The kit is delivered with Quartus Prime software and all of the cables that are required to use the board straight out of the box.



PRODUCT AND VENDOR NAME	DESCRIPTION
<b>STRATIX IV FPGA KITS (CONTINUED)</b>	
100G Development Kit, Stratix IV GT Edition <b>Intel</b>	This kit enables a thorough evaluation of 100G designs. It supports 10G/40G line interfaces through optical modules, and applications requiring external memory interfaces through four x18 QDR II and four x32 DDR3 memory banks. With this kit, you can evaluate transceiver performance up to 11.3 Gbps, verify PMA compliance to standards, such as 10G/40G/100G Ethernet, Interlaken, CEI-6G/11G, Serial RapidIO, PCIe (Gen1, Gen2, and Gen3), and other major standards. This kit can also validate interoperability between optical modules, such as SFP, SFP+, QSFP, and CFP.
Transceiver Signal Integrity Kit, Stratix IV GX Edition <b>Intel</b>	This kit features eight full-duplex transceiver channels with SMA connectors, 156.25 MHz, 155.52 MHz, 125 MHz, 100 MHz, and 50 MHz clock oscillators, six user pushbuttons, eight DIP switches, eight user LEDs, a 7-segment LCD display, power and temperature measurement circuitry, and Ethernet, USB, and JTAG ports.
Transceiver Signal Integrity Development Kit, Stratix IV GT Edition <b>Intel</b>	This kit enables a thorough evaluation of transceiver interoperability and SERDES signal integrity by allowing you to evaluate transceiver performance up to 11.3 Gbps. You can generate and check PRBS patterns via a simple-to-use GUI, change differential output voltage (VOD), pre-emphasis, and equalization settings to optimize transceiver performance for your channel, perform jitter analysis, verify PMA compliance to 40G/100G Ethernet, Interlaken, CEI-6G/11G, PCIe (Gen1, Gen2, and Gen3), Serial RapidIO, and other major standards, and validate interoperability between optical modules.
S4-3U-VPX (S43X) <b>BittWare</b>	This commercial or rugged 3U VPX card is based on Intel's Stratix IV GX FPGA that is designed specifically for serial I/O-based applications, creating a completely flexible, reconfigurable VPX board. BittWare's ATLANTiS FrameWork and the FINE Host/Control Bridge greatly simplify application development and integration of this powerful board. The board provides a configurable 25-port SERDES interface supporting a variety of protocols, including Serial RapidIO, PCIe, and 10GbE. The board also features 10/100/1000 Ethernet, and up to 4 GB of DDR3 SDRAM. The VITA 57-compliant FMC site provides enhanced flexibility, which supports 10 SERDES, 60 LVDS pairs, and 6 clocks.
SP/D4-AMC (D4AM) <b>BittWare</b>	This board features the I/O processing power of two Intel Stratix IV FPGAs and is a mid- or full-size, single-width AdvancedMC that can be attached to AdvancedTCA carriers or other cards equipped with AMC bays, and used in MicroTCA systems. An Intel Stratix IV GX FPGA paired with a Stratix IV E FPGA makes the D4AM an extremely high-density, flexible board. The FPGAs are connected by two full-duplex 2 Gbps lanes of parallel I/O for data sharing. Each FPGA supports BittWare's ATLANTiS FrameWork to greatly simplify application development and integration. A VITA 57-compliant FMC site provides enhanced flexibility, which connects directly to the Stratix IV E FPGA for LVDS and to the Stratix IV GX FPGA for SERDES. The board also provides an IPMI system management interface and a configurable 18-port AMC SERDES interface supporting a variety of protocols. Onboard memory includes up to 1 GB of DDR3 SDRAM and 128 MB of flash memory, and Ethernet is available via the AMC front and rear panels. It is also available with A/D and D/A conversion options.
SP/S4-AMC (S4AM) <b>BittWare</b>	This board is based on Intel's Stratix IV FPGA and is a mid- or full-size, single-width AdvancedMC that can be attached to AdvancedTCA carriers or other cards equipped with AMC bays, and used in MicroTCA systems. The S4AM features a high-density, low-power Intel Stratix IV GX FPGA designed specifically for serial I/O-based applications, creating a completely flexible, reconfigurable AMC. Providing enhanced flexibility is the VITA 57-compliant FMC site, which features eight SERDES, 80 LVDS pairs, and 6 clocks directly to the FPGA. BittWare's ATLANTiS FrameWork, in conjunction with the FINE III Host/Control Bridge, greatly simplifies application development and integration of this powerful board. The board also provides an IPMI system management interface, a configurable 15-port AMC SERDES interface supporting a variety of protocols, and a front panel 4x SERDES interface supporting CPRI and OBSAI. Additionally, the board features 10/100 Ethernet, GbE, two banks of DDR3 SDRAM, two banks of QDR II+ SRAM, and flash memory for booting the FPGAs and FINE. It is also available with A/D and D/A conversion options.
4S-XMC (4SXM) <b>BittWare</b>	This is a single-width switched mezzanine card (XMC), designed to provide powerful FPGA processing and high-speed serial I/O capabilities to VME, VXS, VPX, cPCI, AdvancedTCA, or PCIe carrier boards. The 4SXM features a high-density, low-power Intel Stratix IV GX FPGA, which was designed specifically for serial I/O-based applications and is PCI-SIG* compliant for PCIe Gen1 and Gen2. Four SFP compact optical transceivers are available on the front panel. There are eight multi-gigabit serial lanes supporting PCIe, Serial RapidIO, and 10GbE available via the board's rear panel, as well as 44 general-purpose digital I/O signals. The 4SXM also provides QDR II+ SRAM and flash memory.
PROCe IV <b>GiDel</b>	This Intel-based PCIe x4 platform is ideal for high-speed data acquisition, algorithmic acceleration, IP validation, and verification of small SoCs. This board has five levels of memory structure (8.5 GB+) with maximum sustainable throughput of 4,693 GBps for internal memories and 12 GBps for DRAM.

PRODUCT AND VENDOR NAME	DESCRIPTION
<b>STRATIX IV FPGA KITS (CONTINUED)</b>	
PROC104 <b>GiDel</b>	This is a PCIe/104 standard Intel-based platform incorporating compact, self-stacking, and rugged industrial-standard connectors. This powerful platform is ideal for high-performance FPGA development and deployment across a range of size, weight, and power-constrained (SWaP-constrained) application areas, including signal intelligence, image processing, software-defined radio, and autonomous modules, or vehicles. The PROC104 can be hosted via 4-lane PCIe and is stackable. The board's high-speed performance coupled with memory and add-on daughterboards' flexible architecture enable the system to meet almost any computational needs. In addition to 512 MB onboard memory, two SODIMM sockets provide up to 8 GB of memory.
PROCStar IV <b>GiDel</b>	This full-length PCIe x8 card is based on Intel's Stratix IV E FPGAs. It provides a high-capacity, high-speed FPGA-based platform fortified with high throughput and massive memory resulting in a powerful and highly flexible system. The performance, memory, and add-on daughterboards' flexible architecture enable the system to meet almost any computation needs. In addition to 2 GB onboard memory, 8 SODIMM sockets provide up to 32 GB of memory or additional connectivity and logic. The largest FPGA-based supercomputer at the National Science Foundation Center for High-Performance Reconfigurable Computing (NSF CHREC) center houses 100 of these cards (400 Intel FPGAs) and is used for Bio-RC, HFT, data mining, and seismic analysis applications.
ProcSoC3-4S system <b>GiDel</b>	ProcSoC Verification System provides scalability of multiple interconnected FPGA modules, enabling verification of SoC designs from 6 million to 360 million equivalent ASIC gates. Each ProcSoC module itself is a modular and scalable SoC verification system. Fast GbE connection combined with GiDEL's development tools enable it to run the target software or regression suites via remote servers connected to the SoC/ASIC design. The remote operation is performed at near actual system speed allowing for hardware-software integration and co-verification. Two chassis configurations are available, ProcSoC3 and ProcSoC10, capable of supporting up to 3 or 10 PROC12M boards, respectively. Each ProcSoC system can prototype a single SoC or be partitioned to prototype multiple designs in parallel. The ProcSoC's unique interconnectivity topology enables any FPGA to connect directly to any other FPGA in the system even in large systems.
Stratix IV GX/GT 40G/ 100G Interlaken <b>HiTech Global</b>	This board integrates the most fundamental electrical and optical interfaces for building 200G subsystems. It implements CAUI and Interlaken high-speed serial interfaces, industry-leading, high-speed DDR3 SDRAM and QDR II+ SRAM interfaces, and high-speed parallel interconnect for NetLogic knowledge-based processors (KBPs). The modular design enables expansion to support legacy and emerging optical modules.
Xpress GX4 Kit <b>ReFLEX CES</b>	This kit provides a complete hardware and software environment for Intel Stratix IV GX FPGAs. It is built around a PCI form factor card compliant with PCI-SIG and targets the development of designs using PCIe Gen1 or Gen2.
Single-FPGA (Tile) Prototyping Solution <b>Polaris Design Systems</b>	This single-FPGA prototyping board can accommodate up to 15 million gate designs. It has a single Stratix IV FPGA and 18 Mb of SRAM. The board can be used either in a rack-mountable system or as a stand-alone unit.
Multi-FPGA (Logic) Prototyping Solution <b>Polaris Design Systems</b>	This multi-FPGA prototyping board can accommodate up to 30 million gate designs. The board has three Stratix IV FPGAs, SRAM, and 2 GB of DDR3 SDRAM (expandable to 8 GB). The board can be used either in a rack-mountable system or as a stand-alone unit.
DN7002k10MEG <b>The Dini Group</b>	This complete logic emulation system allows you to prototype SoC logic and memory designs. It can operate as a stand-alone system, or be hosted via a USB interface. A single system, configured with two Stratix IV EP4SE820 FPGAs, can emulate up to 13 million gates. All FPGA resources are available for the target application. Each FPGA position can use any available speed grade.
DN7406k10PCIe-8T <b>The Dini Group</b>	This complete logic prototyping system allows you to prototype logic and memory designs. The DN7406k10PCIe-8T is hosted in an eight-lane PCIe Gen1 bus, but can be used as a stand-alone system configured via USB or CompactFlash. A single board configured with six Intel's Stratix IV EP4SE820 FPGAs can emulate up to 31 million gates. All of the FPGA resources are available for your application, and any combination of speed grades can be used.
DN7020k10 <b>The Dini Group</b>	This complete logic prototyping system gives ASIC and IP designers a vehicle to prototype logic and memory designs using up to 20 Stratix III or Stratix IV devices.
DN7006K10PCIe-8T <b>The Dini Group</b>	This complete logic prototyping system with a dedicated PCIe interface gives ASIC and IP designers a vehicle to prototype logic and memory designs using up to six Stratix III or Stratix IV devices.

PRODUCT AND VENDOR NAME	DESCRIPTION
<b>CYCLONE IV FPGA KITS</b>	
Cyclone IV GX FPGA Development Kit <b>Intel</b>	This kit provides a comprehensive design environment that allows you to quickly develop low-cost and low-power FPGA system-level designs. This kit includes the PCIe short card form factor, two HSMC connectors, and a 10/100/1000 Mbps Ethernet interface. Onboard memory includes 128 MB DDR2 SDRAM, 64 MB flash, and 4 MB SSRAM. This kit also includes SMA connectors, and 50 MHz, 100 MHz, and 125 MHz clock oscillators, as well as user interfaces including pushbuttons, LEDs, and a 7-segment LCD display.
Cyclone IV GX Transceiver Starter Kit <b>Intel</b>	This kit provides a low-cost platform for developing transceiver I/O-based FPGA designs. It includes the complete hardware and software you need to develop your FPGA design for cost-sensitive applications. You can measure the FPGA's power consumption, test the signal quality of the FPGA transceiver I/Os (up to 2.5 Gbps), and develop and test PCIe Gen1 designs.
BeMicro SDK <b>Arrow</b>	This Arrow BeMicro SDK enables a quick and easy evaluation of soft core processors for both embedded software developers and hardware engineers. The kit builds on the success of the original BeMicro evaluation kit by adding features, such as Mobile DDR memory, Ethernet, and even the option of using a file system by slotting in a micro-SD card. The BeMicro SDK connects to a PC via a USB connection, which is used for power, programming, and debugging. Arrow has a number of reference designs and pre-built software templates that can be downloaded for this kit that highlight the benefits of building embedded systems in FPGAs.
DE0-Nano Development Board <b>Terasic Technologies</b> 	The DE0-Nano Development Board is a compact-sized FPGA development platform suited for prototyping circuit designs such as robots and "portable" projects. The board is designed to be used in the simplest possible implementation targeting the Cyclone IV device up to 22,320 LEs. This kit allows you to extend designs beyond the DE0-Nano board with two external general-purpose I/O (GPIO) headers and allows you to handle larger data storage and frame buffering with on-board memory devices including SDRAM and EEPROM. This kit is lightweight, reconfigurable, and suitable for mobile designs without excessive hardware. This kit provides enhanced user peripheral with LEDs and push buttons and three power scheme options including a USB Mini-AB port, 2-pin external power header, and two DC 5-V pins.
Industrial Networking Kit <b>Terasic Technologies</b>	The Industrial Networking Kit (INK) offers a comprehensive development platform for industrial automation and applications. The kit consists of the DE2-115 board featuring the Cyclone IV device and dual 10/100/1000-Mbps Ethernet, 128 MB SDRAM, 8 MB flash memory, 2 MB SRAM, HSMC and GPIO connectors, USB 2.0, an SD card slot, switches and buttons, LEDs, 16x2 display, audio and video, and VGA-out. The kit also includes an Industrial Communications Board (ICB-HSMC) that supports RS-485, RS-232, CAN, and additional I/O expansion.
DE2-115 Development and Education Board <b>Terasic Technologies</b>	This board is part of the DE2 educational development board series and features the Cyclone IV E EP4CE115 FPGA. The DE2-115 offers an optimal balance of low cost, low power, and a rich supply of logic, memory and DSP capabilities, as well as interfaces to support mainstream protocols including GbE. A HSMC connector is provided to support additional functionality and connectivity via HSMC daughtercards and cables.
<b>MAX II CPLD Kits</b>	
MAX II/MAX IIZ Development Kit <b>System Level Solutions</b>	This board provides a hardware platform for designing and developing simple and low-end systems based on MAX II or MAX IIZ devices. The board features a MAX II or MAX IIZ EPM240T100Cx or EPM240ZM100Cx device with 240 LEs and 8,192 bits of user flash memory (UFM). The board also supports vertical migration into EPM570T100Cx devices with 570 LEs and 8,192 bits of UFM.
MAX II Micro <b>Terasic Technologies</b>	This kit, equipped with the largest MAX II CPLD and an onboard USB-Blaster cable, functions as a development and education board for CPLD designs. This kit also includes reference designs with source code.

# SoC SYSTEM ON MODULES

[www.altera.com/soms](http://www.altera.com/soms)

System on modules (SoMs) provide a compact, pre-configured memory and software solution perfect for prototyping, proof-of-concept, and initial system production. SoMs enable you to focus on your IP, algorithms, and human/mechanical interfaces rather than the fundamentals of the SoC and electrical system and software bring-up. In some cases, SoMs can also make sense for full system production.

The following Intel SoC-based SoMs are available now from Intel FPGA DSN partners:

PARTNER	SOM	INTEL SoC	MAIN MEMORY <sup>1</sup>	MODULE IMAGE
Critical Link	MitySOM-5CSX	Cyclone V SoC	Up to 2 GB DDR3 with ECC	
DENX Computer Systems	MCV	Cyclone V SoC	1 GB DDR3 SDRAM	
Enclustra	Mercury SA Mercury+ SA2	Cyclone V SoC	Up to 2 GB DDR3L SDRAM	
Enterpoint	Larg 2	Cyclone V SoC	512 M Byte DDR3 SDRAM	
EXOR International	uS02 microSOM*	Cyclone V SoC	1 GB DDR3 SDRAM	
iWave Systems	Qseven Module	Cyclone V SoC	512 MB DDR3 SDRAM with ECC	
iWave Systems	iW-Rainbow-G24M	Arria 10 SoC	1 GB DDR4 SDRAM, Others upon request.	

**Notes:**

1. Processor main memory only. Additional FPGA, flash memory, eMMC, microSD, SD/MMC, and EEPROM memory may be provided but is not shown in this table. Consult SoM vendor specifications for complete memory details.

## Development Kits

PARTNER	SOM	INTEL SoC	MAIN MEMORY <sup>1</sup>	MODULE IMAGE
Macnica	Borax SoM	Cyclone V SoC	1 GB DDR3 SDRAM <sup>1</sup>	
Reflex	Achilles	Arria 10 SoC	8 GB DDR4 SDRAM	
Shiratech	Spark-100	Cyclone V SoC	1 GB to 4 GB DDR3 SDRAM with ECC	
Shiratech	Spark-102 Industrial Ethernet	Cyclone V SoC	Up to 2 GB DDR3 SDRAM with ECC <sup>1</sup>	
Solectrix	SXoM-C5	Cyclone V SoC	1 GB DDR3 SDRAM <sup>1</sup> , Others on request	
NovTech	NOVSOM CV NOVSOM CVLite	Cyclone V SoC	Up to 2 GB DDR3 SDRAM with ECC	
Enclustra	Mercury+ AA1	Arria 10 SoC	8 GB DDR4 SDRAM with ECC	

### Notes:

1. Processor main memory only. Additional FPGA, flash memory, eMMC, microSD, SD/MMC, and EEPROM memory may be provided but is not shown in this table. Consult SoM vendor specifications for complete memory details.

For more information about Intel SoC system on modules, visit [www.altera.com/soms](http://www.altera.com/soms).

# SINGLE-BOARD COMPUTER

While a SoM must be plugged into a carrier board to access the I/Os, single-board computers (SBC) integrate I/O connectors along with the processor and memory. The SBC offering supports a variety of embedded operating systems and provides an integrated FPGA SoC hardware and software solution that accelerates time to market for production OEM and maker markets.

The following Intel SoC-based SBC is available now from Intel FPGA DSN partners:

PARTNER	SBC	INTEL SoC	MAIN MEMORY	MODULE IMAGE
Embedded Planet	EP5CSXxS Single-board computer	Cyclone V SoC	Up to 1 GB DDR3 SDRAM	

# DESIGN SOLUTIONS NETWORK

[www.altera.com/dsn](http://www.altera.com/dsn)



FPGA Design Solutions Network

Intel's FPGA Design Solutions Network (DSN) is a global ecosystem of independent, qualified companies that offer an extensive portfolio of design services, IP, and board products to help customers accelerate their time to market and lower product development risks. DSN members have expertise designing with Intel FPGA products and offer design services ranging from selecting the right devices for a new product design, to multiboard system-level designs and IP integration.

## ACCELERATE PRODUCT DEVELOPMENT

- Use off-the-shelf IP, boards, commercial off-the-shelf (COTS) products, or solutions to reduce your development time
- Evaluate members' board and IP products with quality metrics
- Get online, virtual, or instructor-led training when you need it
- Consult with a member to help you select the right FPGA, SoC, or Enpirion devices
- Get help with new product design feasibility or complex high-performance system design

## MINIMIZE PRODUCT DEVELOPMENT RISKS

You can quickly locate members who offer:

- Intel FPGA, SoC, or Enpirion engineering design services
- Custom development kits, modules, boards, COTS, or IP
- Comprehensive end-market application and Intel FPGA device expertise
- Prototyping, compliance, and manufacturing support

## SUPPORT FROM INTEL

- Members must meet the established criteria to maintain the DSN program membership
- Members qualify for Intel benefits to accelerate customer support

## FPGA Design Solution Network Platinum 2016

Platinum members have the highest level of Intel customer project design or IP/board/COTS product experience.

## FPGA Design Solution Network Gold 2016

Gold members offer a wide range of Intel FPGA device, application, or solution expertise across our product families.

Visit [www.altera.com/dsn](http://www.altera.com/dsn) to view the latest list of Platinum and Gold partners. You can also search for products and design expertise from this web page.

## PLATINUM PARTNERS

Adeas	Intilop
Algo-Logic	IP Cores
ALSE	ipTronix S.r.L
Annapolis Micro Systems	Mercury Systems
Arrive Technologies	MoreThanIP
Bitec	MoSys
Bittware, Inc.	Nallatech
CEVA	Northwest Logic
Coveloz Consulting	Nuvation Engineering
Colorado Engineering	Orchid Technologies
Critical Link	Plexus Corporation
El Camino	ReFlex CES
Exor International	System Level Solutions, Inc.
Foresys	Tata Elxsi
Fujisoft Inc.	Terasic
GiDEL	The Athena Group
HCL Technologies	Tokyo Electron Devices
IntelliProp	Valydate

# TRAINING OVERVIEW

[www.altera.com/training](http://www.altera.com/training)

We offer an extensive curriculum of classes to deepen your expertise. Our classes are beneficial whether you're new to FPGA, CPLD, and SoC design, or are an advanced user wanting an update on the latest tools, tips, and tricks. Our training paths are delivered in three ways:

- Instructor-led training, typically lasting one to two days, involves in-person instruction with hands-on exercises from an Intel or Intel partner subject matter expert. Fees vary.
- Virtual classrooms, involving live instructor-taught training over the Web, allow you to benefit from the interactivity with an instructor from the comfort of your home or office. Classes are taught in 4.5-hour sessions across consecutive days.
- Online training, typically 30 minutes long, features pre-recorded presentations and demonstrations. Online classes are free and can be taken at any time.

To help you decide which courses might be most useful to you, we've grouped classes into specific curricula. Curricula paths include Intel FPGA fundamentals, I/O interfaces, embedded hardware, software development, DSP, and more.

Learn more about our training program or sign up for classes at [www.altera.com/training](http://www.altera.com/training).

Start sharpening your competitive edge today!

The flowchart below gives you an overview of all instructor-led and virtual courses from Intel. The foundation courses are shown at the top. The advanced follow-on courses are shown just below the foundation courses. Specialized courses are shown at the bottom. Any course with a dotted line around it indicates that it is available as either an instructor-led class or as a virtual class. If there is no dotted line around a course then it is only available as an instructor-led course. The arrows show you the order we recommend some of the courses to be taken.

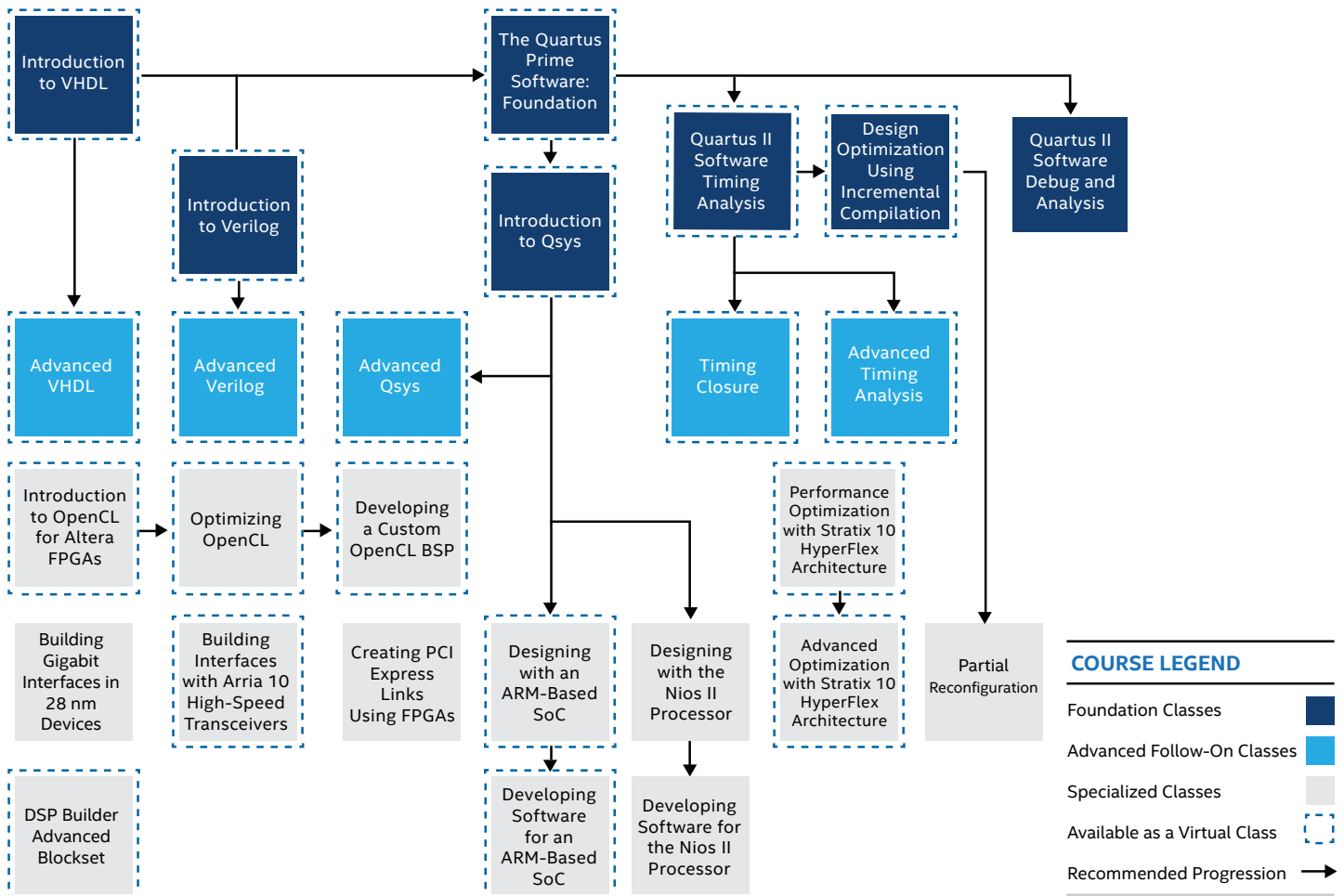



## Instructor-Led and Virtual Classes

VIRTUAL CLASSROOM COURSES DENOTED WITH A †  
(ALL COURSES ARE ONE DAY IN LENGTH UNLESS OTHERWISE NOTED)

COURSE CATEGORY	GENERAL DESCRIPTION	COURSE TITLES
Design languages	Attain the skills needed to design with Verilog HDL and VHDL for programmable logic	<ul style="list-style-type: none"> <li>• Introduction to VHDL†</li> <li>• Advanced VHDL Design Techniques†</li> <li>• Introduction to Verilog HDL†</li> <li>• Advanced Verilog HDL Design Techniques†</li> </ul>
Quartus software	Acquire design entry, compilation, programming, verification, and optimization skills by learning how to use both basic and advanced features of Quartus Prime software	<ul style="list-style-type: none"> <li>• The Quartus Prime Software: Foundation†</li> <li>• The Quartus II Software Debug and Analysis Tools</li> <li>• The Quartus II Software Design Series: Timing Analysis†</li> <li>• Advanced Timing Analysis with TimeQuest†</li> <li>• Timing Closure with the Quartus II Software†</li> <li>• Design Optimization Using Quartus II Incremental Compilation†</li> <li>• Partial Reconfiguration with Altera FPGAs</li> </ul>
Design Optimization Techniques	Learn design techniques and Quartus software features to improve design performance. Note: While the focus of this course is the Stratix 10 device family, many of the techniques you will learn can be used to improve performance in other device architectures.	<ul style="list-style-type: none"> <li>• Performance Optimization with the Stratix 10 HyperFlex Architecture†</li> <li>• Advanced Optimization with the Stratix 10 HyperFlex Architecture†</li> </ul>
Software development	Accelerate algorithm performance with Open Computing Language (OpenCL) by offloading to an FPGA	<ul style="list-style-type: none"> <li>• Introduction to OpenCL for Altera FPGAs†</li> <li>• Optimizing OpenCL for Altera FPGAs†</li> <li>• Developing a Custom OpenCL BSP</li> </ul>
System integration	Build hierarchical systems by integrating IP and custom logic	<ul style="list-style-type: none"> <li>• Introduction to the Qsys System Integration Tool†</li> <li>• Advanced Qsys System Integration Tool Methodologies†</li> </ul>
Embedded system design	Learn to design an ARM-based or Nios II processor system in an Altera FPGA	<ul style="list-style-type: none"> <li>• Designing with the Nios II Processor</li> <li>• Developing Software for the Nios II Processor</li> <li>• Designing with an ARM-based SoC†</li> <li>• Developing Software for an ARM-based SoC†</li> </ul>
System design	Solve DSP and video system design challenges using Altera technology	<ul style="list-style-type: none"> <li>• Designing with DSP Builder Advanced Blockset†</li> </ul>
Connectivity design	Build high-speed, gigabit interfaces using embedded transceivers found in leading-edge FPGA families	<ul style="list-style-type: none"> <li>• Building Interfaces with Arria 10 High-Speed Transceivers†</li> <li>• Building Gigabit Interfaces in 28 nm Devices</li> <li>• Creating PCI Express Links Using FPGAs</li> </ul>

# Online Training

## FREE ONLINE TRAINING COURSES (COURSES ARE APPROXIMATELY 30 MINUTES LONG)

COURSE CATEGORY	COURSE TITLES	LANGUAGES
Getting started	Read Me First!	English, Chinese, and Japanese
	Basics of Programmable Logic: FPGA Architecture	English, Chinese, and Japanese
	Basics of Programmable Logic: History of Digital Logic Design	English, Chinese, and Japanese
	How to Begin a Simple FPGA Design	English, Chinese, and Japanese
	Become an FPGA Designer in 4 Hours	English only
Design languages	VHDL Basics	English, Chinese, and Japanese
	Verilog HDL Basics	English, Chinese, and Japanese
	SystemVerilog with the Quartus II Software	English, Chinese, and Japanese
	Best HDL Design Practices for Timing Closure	English, Chinese, and Japanese
Software overview and design entry	Using the Quartus Prime Software: An Introduction	English and Chinese
	The Quartus Prime Software: Foundation (Pro Edition)	English only
	The Quartus Prime Software: Foundation (Standard Edition)	Chinese and Japanese
	Migrating to the Quartus Prime Pro Edition Software	English and Japanese
	Using Spectra-Q Synthesis in the Quartus Prime Software	English and Japanese
	Incremental Optimization with the Quartus Prime Pro Edition	English only
	Synplify Pro Tips and Tricks	English only
	Synplify Synthesis Techniques with the Quartus II Software	English only
	Using Quartus II Software: Schematic Design	English and Chinese
	Introduction to Incremental Compilation	English, Chinese, and Japanese
	Fast & Easy I/O System Design with BluePrint	English and Japanese
	I/O Signal Integrity Analysis with Third-Party Tools	English and Chinese
	SERDES Channel Simulation with IBIS-AMI Models	English only
	Managing Metastability with the Quartus II Software	English only
Partial Reconfiguration	English and Chinese	
Verification and debugging	Overview of Mentor Graphics ModelSim Software	English and Japanese
	SignalTap II Logic Analyzer	English, Chinese, and Japanese
	Using Quartus II Software: Chip Planner	English only
	Debugging and Communicating with an FPGA Using the Virtual JTAG Megafunction	English only
	System Console	English and Chinese
	Debugging JTAG Chain Integrity	English only
	Power Analysis and Optimization	English and Chinese
	Resource Optimization	English and Chinese
Timing analysis and closure	TimeQuest Timing Analyzer	English, Chinese, and Japanese
	Using Design Space Explorer	English and Japanese
	Timing Closure Using TimeQuest Custom Reporting	English only
	Design Evaluation for Timing Closure	English and Chinese

FREE ONLINE TRAINING COURSES (COURSES ARE APPROXIMATELY ONE HOUR LONG)

COURSE CATEGORY	COURSE TITLES	LANGUAGES
Timing analysis and closure (Continued)	Good High-Speed Design Practices	English only
	Constraining Source Synchronous Interfaces	English and Chinese
	Constraining Double Data Rate Source Synchronous Interfaces	English, Chinese, and Japanese
	Stratix 10 HyperFlex Architecture Overview	English, Chinese, and Japanese
	Quartus Prime Hyper-Aware Design Flow	English, Chinese, and Japanese
	Using Fast Forward Compile for the HyperFlex Architecture	English, Chinese, and Japanese
	Introduction to Hyper-Retiming	English, Chinese, and Japanese
	Eliminating Barriers to Hyper-Retiming	English and Chinese
	Introduction to Hyper-Pipelining	English only
	Introduction to Hyper-Optimization	English only
	Understanding Critical Chains	English only
	Hyper-Optimization Techniques 1: Loop Analysis and Solutions	English only
	Hyper-Optimization Techniques 2: Pre-Computation	English only
	Hyper-Optimization Techniques 3: Shannon's Decomposition	English only
Memory interfaces	Using High Performance Memory Interfaces in Altera 28 nm and 40 nm FPGAs	English and Chinese
	Introduction to Hybrid Memory Cubes with Altera FPGAs	English only
	Implementing the Hybrid Memory Cube Controller IP in an Altera FPGA	English only
	Introduction to Memory Interfaces IP in Arria 10 Devices	English, Chinese, and Japanese
	Integrating Memory Interfaces IP in Arria 10 Devices	English, Chinese, and Japanese
	On-Chip Debugging of Memory Interfaces IP in Arria 10 Devices	English, Chinese, and Japanese
	Verifying Memory Interfaces IP in Arria 10 Devices	English, Chinese, and Japanese
Connectivity design	Transceiver Basics	English, Chinese, and Japanese
	Transceiver Toolkit for 28-nm Devices	English only
	Transceiver Toolkit for Arria 10 Devices	English only
	Generation 10 Transceiver Clocking	English only
	Generation 10 Transceiver Reconfiguration	English only
	Building a Generation 10 Transceiver PHY Layer	English only
	Advanced Signal Conditioning for Stratix IV and Stratix V Receivers	English only
	Introduction to the Arria 10 Hard IP for PCI Express	English only
	Customizing the Arria 10 Hard IP for PCI Express	English only
	Connecting to the Arria 10 Hard IP for PCI Express	English only
	Designing with the Arria 10 Hard IP for PCI Express	English only
	Introduction to the 28 nm Hard IP for PCI Express	English only
	Customizing the 28 nm Hard IP for PCI Express	English only
	Connecting to the 28 nm Hard IP for PCI Express	English only
	Designing with the 28 nm Hard IP for PCI Express	English only
	Getting Started with Altera's 40 nm PCI Express Solutions	English and Japanese
	JESD204B MegaCore IP Overview	English only
	Introduction to the Triple-Speed Ethernet MegaCore Function	English and Chinese
	Implementing the Triple-Speed Ethernet MegaCore Function	English only
Introduction to the 10Gb Ethernet PHY IP Cores	English only	
Introduction to the Low Latency 10Gb Ethernet MAC IP Core	English only	

## FREE ONLINE TRAINING COURSES (COURSES ARE APPROXIMATELY ONE HOUR LONG)

COURSE CATEGORY	COURSE TITLES	LANGUAGES
System design	Introduction to Qsys	English, Chinese, and Japanese
	System Design with Qsys Pro	English only
	Creating a System Design with Qsys	English, Chinese, and Japanese
	Advanced System Design Using Qsys: Component & System Simulation	English only
	Advanced System Design Using Qsys: Qsys System Optimization	English only
	Advanced System Design Using Qsys: System Verification with System Console	English only
	Advanced System Design Using Qsys: Utilizing Hierarchy in Qsys Designs	English only
	Custom IP Development Using Avalon and AXI Interfaces	English, Chinese, and Japanese
	DSP Builder Advanced Blockset: Introduction	English only
	DSP Builder Advanced Blockset: Implementing a Design	English only
	Variable-Precision DSP Blocks in Altera 20 nm FPGAs	English only
	High-Performance Floating-Point Processing with FPGAs	English only
	Building Video Systems	English and Chinese
	Implementing Video Systems	English only
	Creating Reusable Design Blocks: Introduction to IP Reuse	English and Japanese
	Creating Reusable Design Blocks: IP Design & Implementation	English and Japanese
	Creating Reusable Design Blocks: IP Integration with the Quartus II Software	English and Japanese
Avalon Verification Suite	English and Chinese	
OpenCL	Introduction to Parallel Computing with OpenCL	English, Japanese, and Chinese
	Writing OpenCL Programs for Altera FPGAs	English, Japanese, and Chinese
	Running OpenCL on Altera FPGAs	English, Japanese, and Chinese
	OpenCL: Single-Threaded vs. Multi-Threaded Kernels	English, Japanese, and Chinese
	Building Custom Platforms for Altera SDK for OpenCL	English, Japanese, and Chinese
	OpenCL Optimization Techniques: Image Processing Algorithm Example	English only
	OpenCL Optimization Techniques: Secure Hash Algorithm Example	English only

FREE ONLINE TRAINING COURSES (COURSES ARE APPROXIMATELY ONE HOUR LONG)

COURSE CATEGORY	COURSE TITLES	LANGUAGES
Embedded system design	Designing with the Nios II Processor and Qsys - Day 1	Japanese only
	Nios II Software Tools and Design Flow	English and Japanese
	Developing Software for the Nios II Processor: Tools Overview	Chinese only
	Developing Software for the Nios II Processor: Design Flow	Chinese only
	Hardware Design Flow for an ARM-Based SoC	English, Chinese, and Japanese
	Software Design Flow for an ARM-Based SoC	English, Chinese, and Japanese
	Getting Started with Linux for Altera SoCs	English and Japanese
	SoC Bare-metal Programming and Hardware Libraries	English only
	SoC Hardware Overview: Flash Controllers and Interface Protocols	English and Chinese
	SoC Hardware Overview: Interconnect and Memory	English and Chinese
	SoC Hardware Overview: System Management, Debug, and General Purpose Peripherals	English and Chinese
	SoC Hardware Overview: the Microprocessor Unit	English and Chinese
	Creating Second Stage Bootloader for Altera SoCs	English only
	Using the Nios II Processor	Chinese only
	Using the Nios II Processor: Custom Components and Instructions	English only
	Using the Nios II Processor: Hardware Development	English only
	Using the Nios II Processor: Software Development	English only
	Developing Software for the Nios II Processor: Nios II Software Build Tools for Eclipse	English and Japanese
	Nios II Software Build Tools for Eclipse and BSP Editor (Quartus II Software 10.0 Update)	English only
	Developing Software for the Nios II Processor: HAL Primer	English, Chinese, and Japanese
Lauterbach Debug Tools	English only	
Introduction to Graphics	English only	
Device-specific training	Introduction to Configuring Altera FPGAs	English and Chinese
	Configuration Schemes for Altera FPGAs	English and Chinese
	Configuration Solutions for Altera FPGAs	English and Chinese
	Integrating an Analog to Digital Converter in MAX 10 Devices	English only
	Introduction to Analog to Digital Conversion in MAX 10 Devices	English only
	Using the ADC Toolkit in MAX 10 Devices	English only
	Using the MAX 10 User Flash Memory	English only
	Using the MAX 10 User Flash Memory with the Nios II Processor	English only
	Introduction to Remote System Upgrade in MAX 10 Devices	English, Chinese, and Japanese
	Remote System Upgrade in MAX 10 Devices: Design Flow & Demonstration	English, Chinese, and Japanese
	Mitigating Single Event Upsets in Arria 10 Devices	English and Japanese
Scripting	Command-Line Scripting	English only
	Introduction to Tcl	English and Chinese
	Quartus II Software Tcl Scripting	English, Chinese, and Japanese









